

YUSON·雍成

thermostatic faucets
for 2024

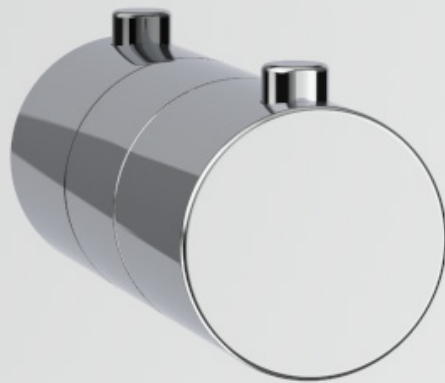
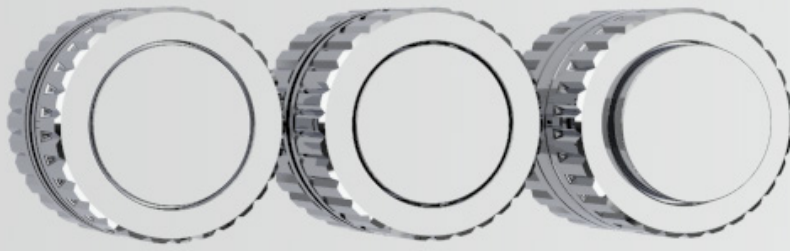

Yuson 雍成
WE BRING YOU VALUE

Shanghai Yuson Industry Co., Ltd | Yuson Group Limited(HK)

A: 18F No. 1690 Kongjiang Road, Shanghai, 200092, China

T: +8621 61075090, 61428791, 61428790

E: yuson@yusongroup.com

W: <https://www.yusongroup.com>



scan  to learn more

The content of this catalogue is limited, Yuson has abilities to provide OEM and ODM services for all our customers. If you don't find your favorite product in our catalogue, please contact our team at the first time, we will provide you with a one-stop solution according to your specific needs.

Copyright © Shanghai Yuson Industry Co., Ltd. All Rights Reserved.

THERMOSTATIC VALVES, FAUCETS

In the old days Shower Faucets were not all temperature balanced. A thermostatic shower faucet guarantees that the water will stay in a desired range even if someone flushes the toilet or turns on the water in another part of the house. Thermostatic valves also offer anti-scald protection.



BUTTON SWITCH

NEOPERL FSG D8 Bolt Fit
18.4151.000
flow, stop and go®

THE NEW TECHNOLOGY FROM NEOPERL

Manually operated, bi-stable on/off control cartridge for sanitary tapware and technical applications.



Technical Characteristics

- Nominal diameter: D8
- Materials: POM, PPS, PPE, EPDM (elastomers), stainless steel (springs)
- Wetted surface area: 7326 mm²
- Designed to comply with sanitary tapware performance standards, e.g. EN817 and ASME A112.18.1
- Materials in water contact comply with international drinking water certifications

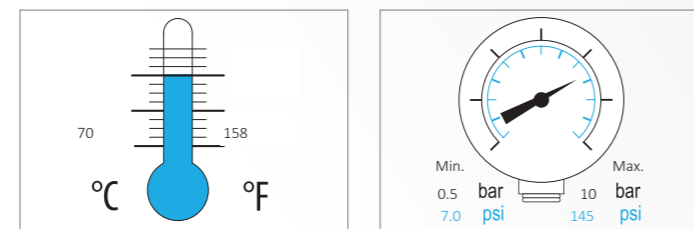
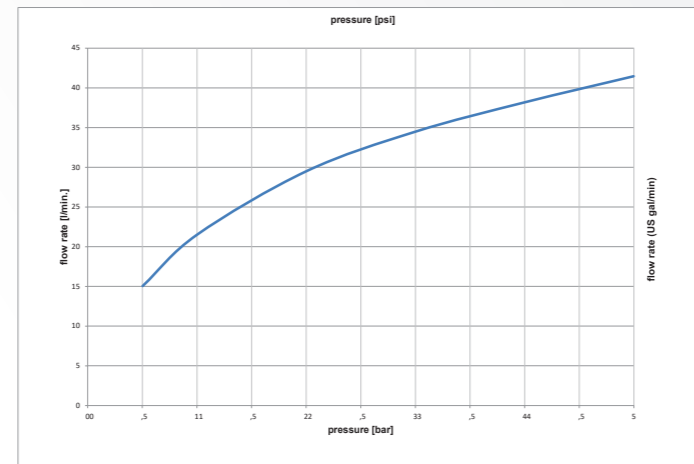
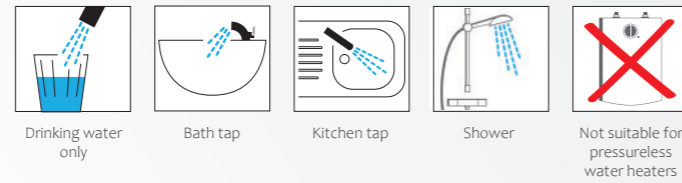

Max. 1h at 90°C/194°F. Indicated pressure values refer to supply line pressure.

Durability:
Endurance test ASME A 112.18.1: 500 000 operation cycles

BUTTON SWITCH VOLUME CONTROL

NEOPERL FSG D8 Volume Control (VC)
18.4155.000
flow, stop and go®

THE NEW TECHNOLOGY FROM NEOPERL

Manually operated on/off cartridge with precision volume control (range @ 3 bar: ~ 6-30 l/min).

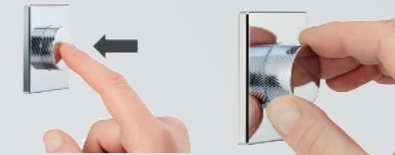

Technical Characteristics

- Nominal diameter: D8
- Materials: POM, PPS, PPE, EPDM (elastomers), stainless steel (springs)
- Wetted surface area: 7327 mm²
- Designed to comply with sanitary tapware performance standards, e.g. EN817 and ASME A112.18.1
- materials in water contact comply with international drinking water certifications

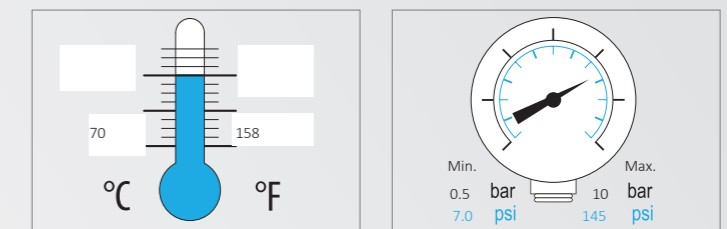
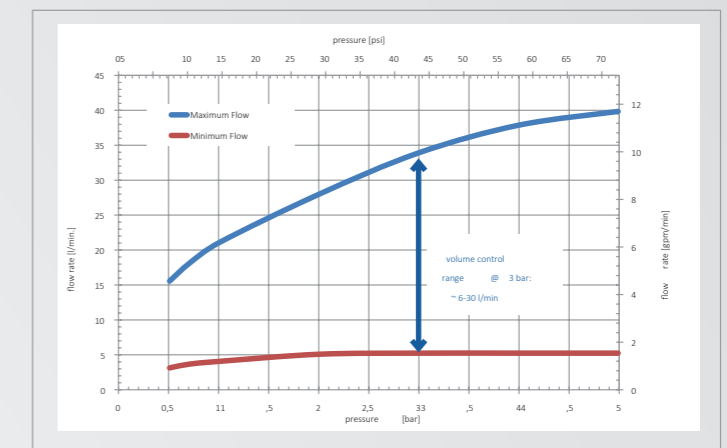
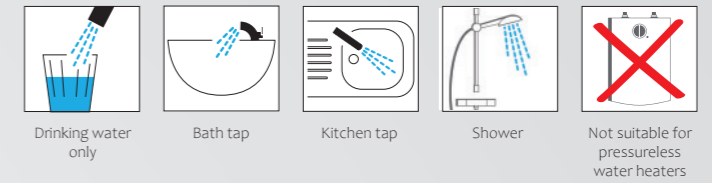

Max. 1h at 90°C/194°F. Indicated pressure values refer to supply line pressure.

Durability:
Endurance test ASME A 112.18.1: 500 000 operation cycles

BUTTON SWITCH

Square thermostatic shower valve with Neoperl push-button ON/OFF



Solid brass casting construction embeded shower valve, long life-time



Manually operated, bi-stable on/off control cartridge for sanitary tapware and technical applications.



Push button switch, easy control

BUTTON SWITCH WITH VOLUME CONTROL

Manually operated, bi-stable on/off control cartridge for sanitary tapware and technical applications.



Solid brass casting construction embeded shower valve, long life-time



Manually operated on/off cartridge with precision volume control (range @ 3 bar: ~ 6-30 l/min).



Push button switch with water volume control, easy control



5101-1-CP

Embeded thermostatic shower valve

- 1-way H59 high quality casting brass body, Zinc handle
- Stainless steel 201/304 decoration plate
- Neoperl push-button cartridge
- PPA thermostatic cartridge+Vemet thermostatic sensor
- Finishing: ASS24H, chrome plated, other color optional

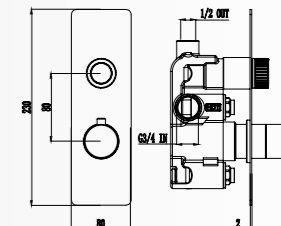

5101-1-MB

Embeded thermostatic shower valve

- 1-way H59 high quality casting brass body, Zinc handle
- Stainless steel 201/304 decoration plate
- Neoperl push-button cartridge
- PPA thermostatic cartridge+Vemet thermostatic sensor
- Finishing: ASS24H, electrophoresis Matte Black, other color optional

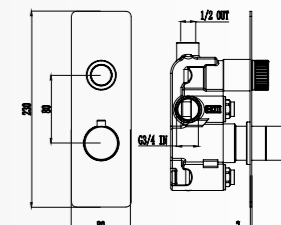

5101-1-BG

Embeded thermostatic shower valve

- 1-way H59 high quality casting brass body, Zinc handle
- Stainless steel 201/304 decoration plate
- Neoperl push-button cartridge
- PPA thermostatic cartridge+Vemet thermostatic sensor
- Finishing: ASS24H, PVD+Nano coating, anti-fingerprint, other color optional

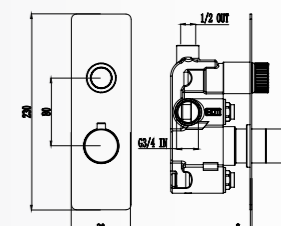

5101F-1-CP

Embeded thermostatic shower valve

- 1-way H59 high quality casting brass body, Zinc handle
- Stainless steel 201/304 decoration plate
- Neoperl push-button cartridge, volume control
- PPA thermostatic cartridge+Vemet thermostatic sensor
- Finishing: ASS24H, chrome plated, other color optional

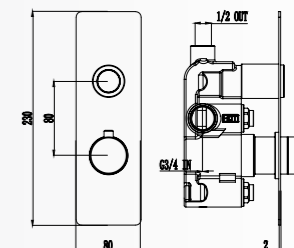

5101F-1-MB

Embeded thermostatic shower valve

- 1-way H59 high quality casting brass body, Zinc handle
- Stainless steel 201/304 decoration plate
- Neoperl push-button cartridge, volume control
- PPA thermostatic cartridge+Vemet thermostatic sensor
- Finishing: ASS24H, electrophoresis Matte Black, other color optional

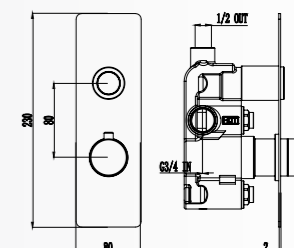

5101F-1-BG

Embeded thermostatic shower valve

- 1-way H59 high quality casting brass body, Zinc handle
- Stainless steel 201/304 decoration plate
- Neoperl push-button cartridge, volume control
- PPA thermostatic cartridge+Vemet thermostatic sensor
- Finishing: ASS24H, PVD+Nano coating, anti-fingerprint, other color optional

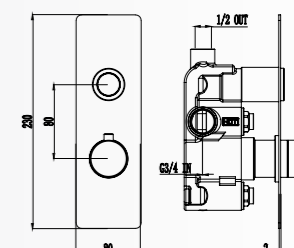

BUTTON SWITCH

Square thermostatic shower valve with Neoperl push-button ON/OFF



Solid brass casting construction embedded shower valve, long life-time



Manually operated, bi-stable on/off control cartridge for sanitary tapware and technical applications.



Push button switch, easy control

BUTTON SWITCH WITH VOLUME CONTROL

Manually operated, bi-stable on/off control cartridge for sanitary tapware and technical applications.



Solid brass casting construction embedded shower valve, long life-time



Manually operated on/off cartridge with precision volume control (range @ 3 bar: ~ 6-30 l/min).



Push button switch with water volume control, easy control



5101-2-CP

Embedded thermostatic shower valve

- 2-way H59 high quality casting brass body, Zinc handle
- Stainless steel 201/304 decoration plate
- Neoperl push-button cartridge
- PPA thermostatic cartridge+Vemet thermostatic sensor
- Finishing: ASS24H, chrome plated, other color optional

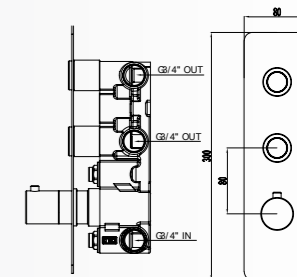

5101-2-MB

Embedded thermostatic shower valve

- 2-way H59 high quality casting brass body, Zinc handle
- Stainless steel 201/304 decoration plate
- Neoperl push-button cartridge
- PPA thermostatic cartridge+Vemet thermostatic sensor
- Finishing: ASS24H, electrophoresis Matte Black, other color optional

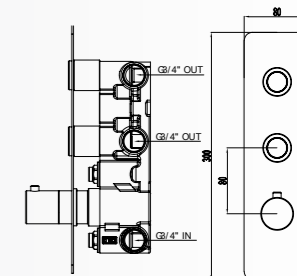

5101-2-BG

Embedded thermostatic shower valve

- 2-way H59 high quality casting brass body, Zinc handle
- Stainless steel 201/304 decoration plate
- Neoperl push-button cartridge
- PPA thermostatic cartridge+Vemet thermostatic sensor
- Finishing: ASS24H, PVD+Nano coating, anti-fingerprint, other color optional

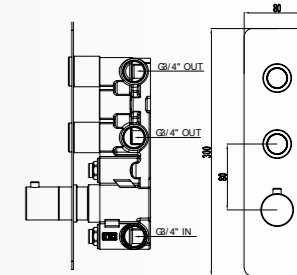

5101F-2-CP

Embedded thermostatic shower valve

- 2-way H59 high quality casting brass body, Zinc handle
- Stainless steel 201/304 decoration plate
- Neoperl push-button cartridge, volume control
- PPA thermostatic cartridge+Vemet thermostatic sensor
- Finishing: ASS24H, chrome plated, other color optional

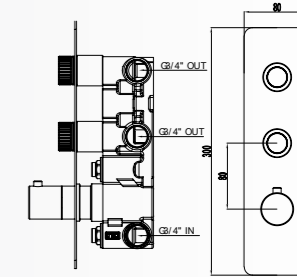

5101F-2-MB

Embedded thermostatic shower valve

- 2-way H59 high quality casting brass body, Zinc handle
- Stainless steel 201/304 decoration plate
- Neoperl push-button cartridge, volume control
- PPA thermostatic cartridge+Vemet thermostatic sensor
- Finishing: ASS24H, electrophoresis Matte Black, other color optional

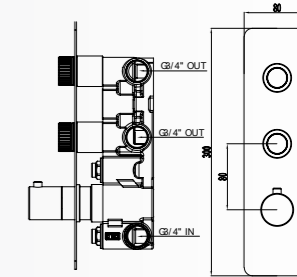

5101F-2-BG

Embedded thermostatic shower valve

- 2-way H59 high quality casting brass body, Zinc handle
- Stainless steel 201/304 decoration plate
- Neoperl push-button cartridge, volume control
- PPA thermostatic cartridge+Vemet thermostatic sensor
- Finishing: ASS24H, PVD+Nano coating, anti-fingerprint, other color optional

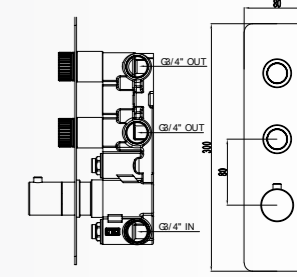

BUTTON SWITCH

Square thermostatic shower valve with Neoperl push-button ON/OFF



Solid brass casting construction embeded shower valve, long life-time



Manually operated, bi-stable on/off control cartridge for sanitary tapware and technical applications.



Push button switch, easy control

BUTTON SWITCH WITH VOLUME CONTROL

Manually operated, bi-stable on/off control cartridge for sanitary tapware and technical applications.



Solid brass casting construction embeded shower valve, long life-time



Manually operated on/off cartridge with precision volume control (range @ 3 bar: ~ 6-30 l/min).



Push button switch with water volume control, easy control



5101C-2-CP

Embeded thermostatic shower valve

- 2-way H59 high quality casting brass body, Zinc handle
- Stainless steel 201/304 decoration plate
- Neoperl push-button cartridge
- PPA thermostatic cartridge+Vemet thermostatic sensor
- Finishing: ASS24H, chrome plated, other color optional

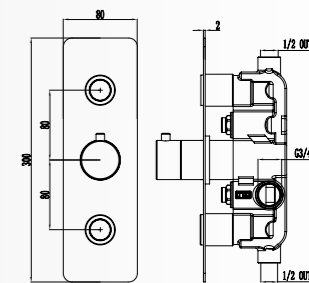

5101C-2-MB

Embeded thermostatic shower valve

- 2-way H59 high quality casting brass body, Zinc handle
- Stainless steel 201/304 decoration plate
- Neoperl push-button cartridge
- PPA thermostatic cartridge+Vemet thermostatic sensor
- Finishing: ASS24H, electrophoresis Matte Black, other color optional

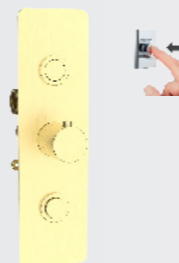
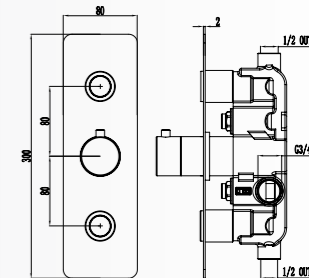

5101C-2-BG

Embeded thermostatic shower valve

- 2-way H59 high quality casting brass body, Zinc handle
- Stainless steel 201/304 decoration plate
- Neoperl push-button cartridge
- PPA thermostatic cartridge+Vemet thermostatic sensor
- Finishing: ASS24H, PVD+Nano coating, anti-fingerprint, other color optional

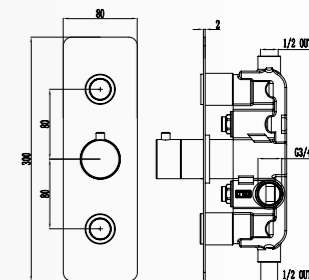

5101CF-2-CP

Embeded thermostatic shower valve

- 2-way H59 high quality casting brass body, Zinc handle
- Stainless steel 201/304 decoration plate
- Neoperl push-button cartridge, volume control
- PPA thermostatic cartridge+Vemet thermostatic sensor
- Finishing: ASS24H, chrome plated, other color optional

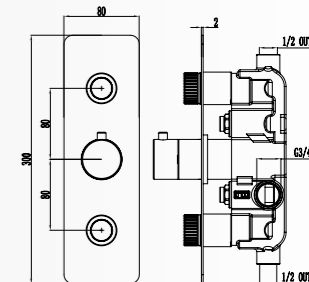

5101CF-2-MB

Embeded thermostatic shower valve

- 2-way H59 high quality casting brass body, Zinc handle
- Stainless steel 201/304 decoration plate
- Neoperl push-button cartridge, volume control
- PPA thermostatic cartridge+Vemet thermostatic sensor
- Finishing: ASS24H, electrophoresis Matte Black, other color optional

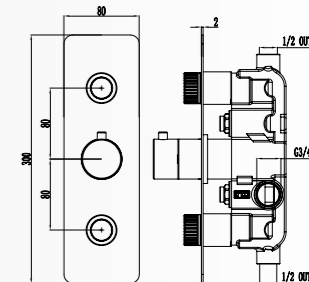

5101CF-2-BG

Embeded thermostatic shower valve

- 2-way H59 high quality casting brass body, Zinc handle
- Stainless steel 201/304 decoration plate
- Neoperl push-button cartridge, volume control
- PPA thermostatic cartridge+Vemet thermostatic sensor
- Finishing: ASS24H, PVD+Nano coating, anti-fingerprint, other color optional

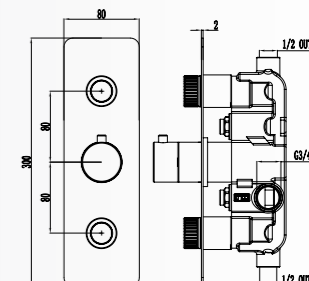

BUTTON SWITCH

Square thermostatic shower valve with Neoperl push-button ON/OFF

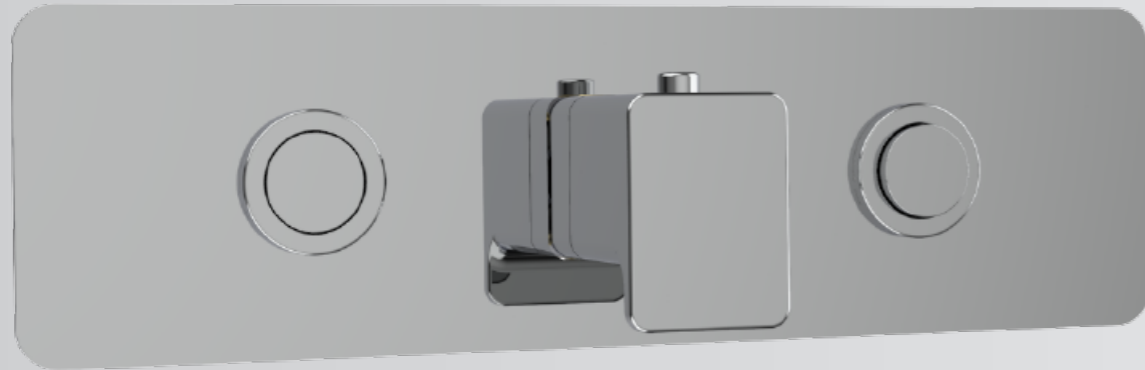

Solid brass casting construction
embeded shower valve, long
life-time



Manually operated, bi-stable
on/off control cartridge for
sanitary tapware and technical
applications.



Push button switch, easy control



5101B-2-CP

Embeded thermostatic shower valve

- 2-way H59 high quality casting brass body, Zinc handle
- Stainless steel 201/304 decoration plate
- Neoperl push-button cartridge
- PPA thermostatic cartridge+Vernet thermostatic sensor
- Finishing: ASS24H, chrome plated, other color optional

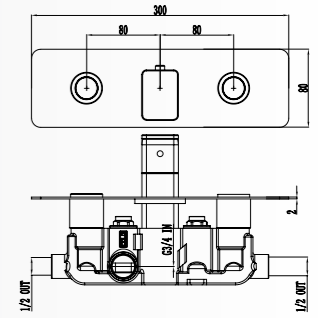

5101B-2-MB

Embeded thermostatic shower valve

- 2-way H59 high quality casting brass body, Zinc handle
- Stainless steel 201/304 decoration plate
- Neoperl push-button cartridge
- PPA thermostatic cartridge+Vernet thermostatic sensor
- Finishing: ASS24H, electrophoresis Matte Black, other color optional

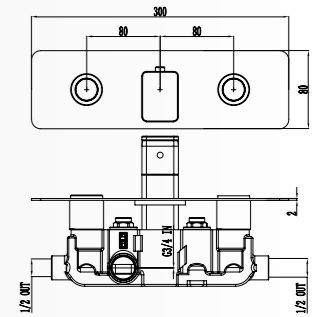

5101B-2-BG

Embeded thermostatic shower valve

- 2-way H59 high quality casting brass body, Zinc handle
- Stainless steel 201/304 decoration plate
- Neoperl push-button cartridge
- PPA thermostatic cartridge+Vernet thermostatic sensor
- Finishing: ASS24H, PVD+Nano coating, anti-fingerprint, other color optional

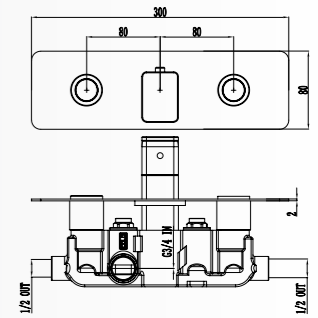

BUTTON SWITCH

Square thermostatic shower valve with Neoperl push-button ON/OFF



Solid brass casting construction embeded shower valve, long life-time



Manually operated, bi-stable on/off control cartridge for sanitary tapware and technical applications.



Push button switch, easy control

BUTTON SWITCH WITH VOLUME CONTROL

Manually operated, bi-stable on/off control cartridge for sanitary tapware and technical applications.

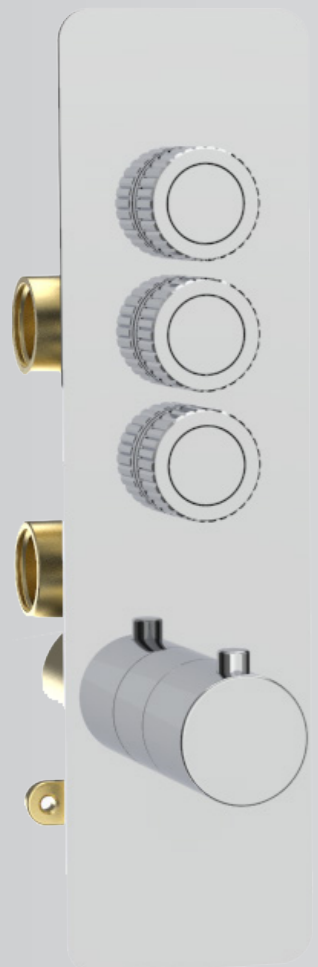

Solid brass casting construction embeded shower valve, long life-time



Manually operated on/off cartridge with precision volume control (range @ 3 bar: ~ 6-30 l/min).



Push button switch with water volume control, easy control



5101C-3-CP

Embeded thermostatic shower valve

- 3-way H59 high quality casting brass body, Zinc handle
- Stainless steel 201/304 decoration plate
- Neoperl push-button cartridge
- PPA thermostatic cartridge+Vemet thermostatic sensor
- Finishing: ASS24H, chrome plated, other color optional

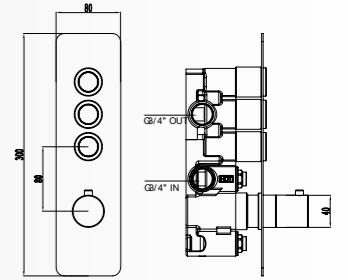

5101C-3-MB

Embeded thermostatic shower valve

- 3-way H59 high quality casting brass body, Zinc handle
- Stainless steel 201/304 decoration plate
- Neoperl push-button cartridge
- PPA thermostatic cartridge+Vemet thermostatic sensor
- Finishing: ASS24H, electrophoresis Matte Black, other color optional

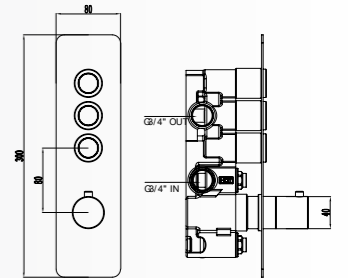

5101C-3-BG

Embeded thermostatic shower valve

- 3-way H59 high quality casting brass body, Zinc handle
- Stainless steel 201/304 decoration plate
- Neoperl push-button cartridge
- PPA thermostatic cartridge+Vemet thermostatic sensor
- Finishing: ASS24H, PVD+Nano coating, anti-fingerprint, other color optional

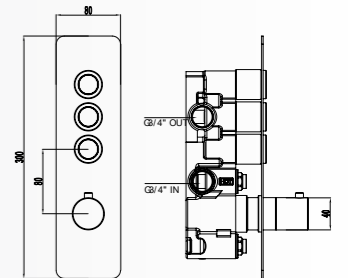

5101CF-3-CP

Embeded thermostatic shower valve

- 3-way H59 high quality casting brass body, Zinc handle
- Stainless steel 201/304 decoration plate
- Neoperl push-button cartridge, volume control
- PPA thermostatic cartridge+Vemet thermostatic sensor
- Finishing: ASS24H, chrome plated, other color optional

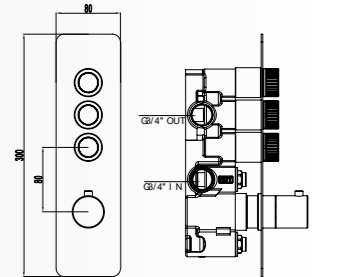

5101CF-3-MB

Embeded thermostatic shower valve

- 3-way H59 high quality casting brass body, Zinc handle
- Stainless steel 201/304 decoration plate
- Neoperl push-button cartridge, volume control
- PPA thermostatic cartridge+Vemet thermostatic sensor
- Finishing: ASS24H, electrophoresis Matte Black, other color optional

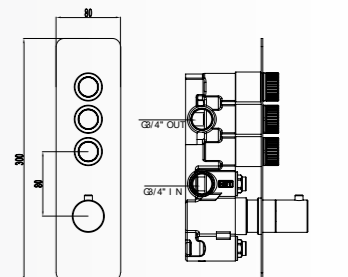

5101CF-3-BG

Embeded thermostatic shower valve

- 3-way H59 high quality casting brass body, Zinc handle
- Stainless steel 201/304 decoration plate
- Neoperl push-button cartridge, volume control
- PPA thermostatic cartridge+Vemet thermostatic sensor
- Finishing: ASS24H, PVD+Nano coating, anti-fingerprint, other color optional

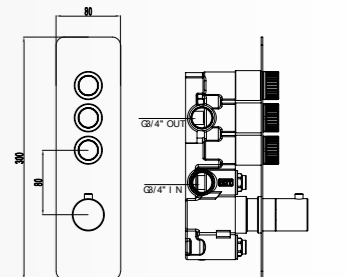

BUTTON SWITCH

Round thermostatic shower valve with Neoperl push-button ON/OFF

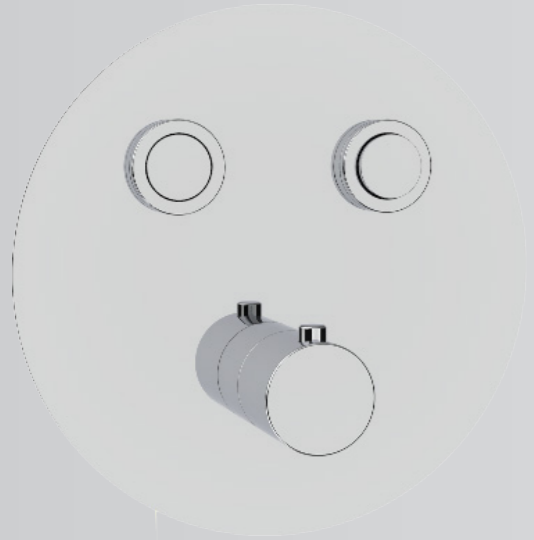

Solid brass casting construction embedded shower valve, long life-time



Manually operated, bi-stable on/off control cartridge for sanitary tapware and technical applications.



Push button switch, easy control

BUTTON SWITCH WITH VOLUME CONTROL

Manually operated, bi-stable on/off control cartridge for sanitary tapware and technical applications.

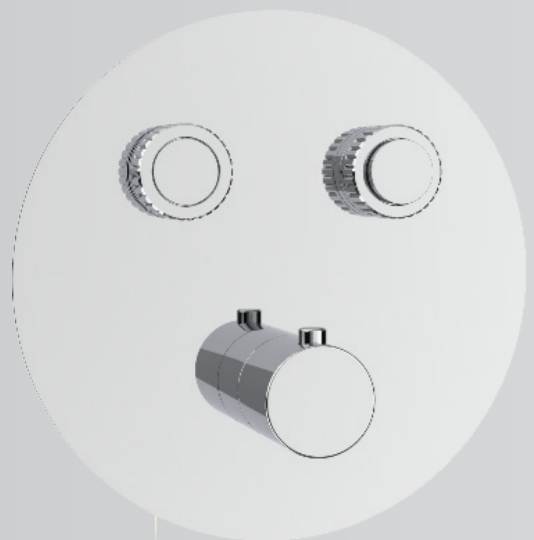

Solid brass casting construction embedded shower valve, long life-time



Manually operated on/off cartridge with precision volume control (range @ 3 bar: ~ 6-30 l/min).



Push button switch with water volume control, easy control



5102-2-CP

Embedded thermostatic shower valve

- 2-way H59 high quality casting brass body, Zinc handle
- Stainless steel 201/304 decoration plate
- Neoperl push-button cartridge
- PPA thermostatic cartridge+Vemet thermostatic sensor
- Finishing: ASS24H, chrome plated, other color optional

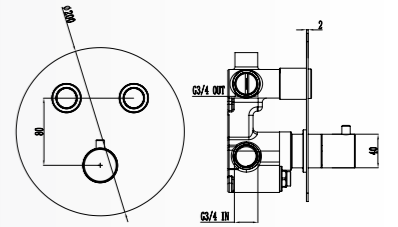

5102-2-MB

Embedded thermostatic shower valve

- 2-way H59 high quality casting brass body, Zinc handle
- Stainless steel 201/304 decoration plate
- Neoperl push-button cartridge
- PPA thermostatic cartridge+Vemet thermostatic sensor
- Finishing: ASS24H, electrophoresis Matte Black, other color optional

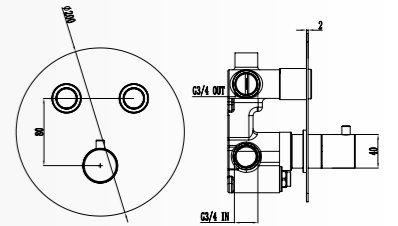

5102-2-BG

Embedded thermostatic shower valve

- 2-way H59 high quality casting brass body, Zinc handle
- Stainless steel 201/304 decoration plate
- Neoperl push-button cartridge
- PPA thermostatic cartridge+Vemet thermostatic sensor
- Finishing: ASS24H, PVD+Nano coating, anti-fingerprint, other color optional

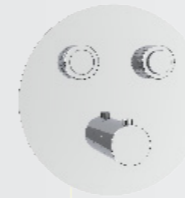
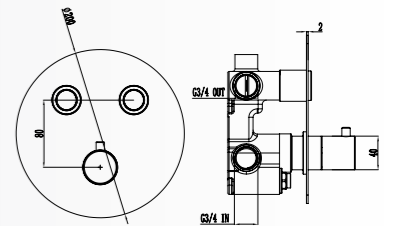

5102F-2-CP

Embedded thermostatic shower valve

- 2-way H59 high quality casting brass body, Zinc handle
- Stainless steel 201/304 decoration plate
- Neoperl push-button cartridge, volume control
- PPA thermostatic cartridge+Vemet thermostatic sensor
- Finishing: ASS24H, chrome plated, other color optional

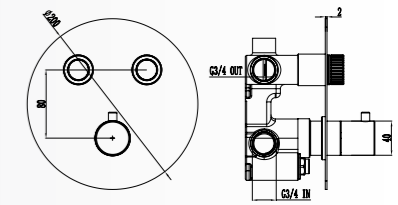

5102F-2-MB

Embedded thermostatic shower valve

- 2-way H59 high quality casting brass body, Zinc handle
- Stainless steel 201/304 decoration plate
- Neoperl push-button cartridge, volume control
- PPA thermostatic cartridge+Vemet thermostatic sensor
- Finishing: ASS24H, electrophoresis Matte Black, other color optional

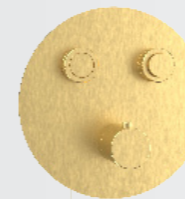
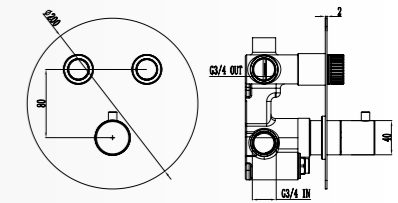

5102F-2-BG

Embedded thermostatic shower valve

- 2-way H59 high quality casting brass body, Zinc handle
- Stainless steel 201/304 decoration plate
- Neoperl push-button cartridge, volume control
- PPA thermostatic cartridge+Vemet thermostatic sensor
- Finishing: ASS24H, PVD+Nano coating, anti-fingerprint, other color optional

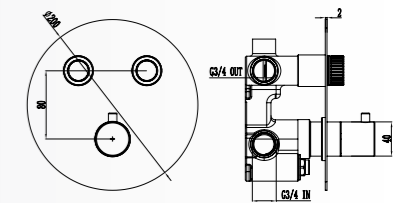

BUTTON SWITCH

Round thermostatic shower valve with Neoperl push-button ON/OFF

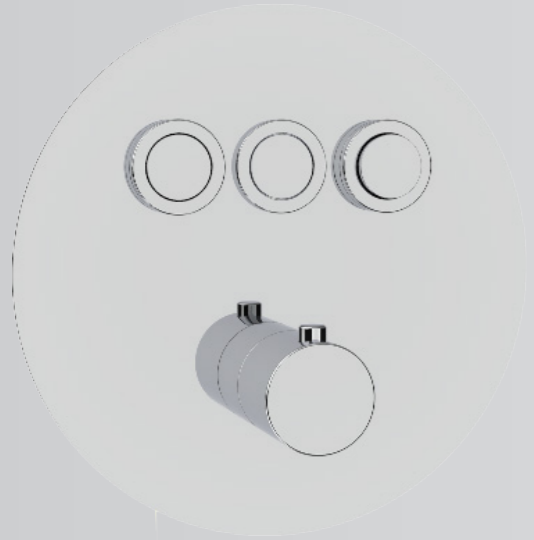

Solid brass casting construction embeded shower valve, long life-time



Manually operated, bi-stable on/off control cartridge for sanitary tapware and technical applications.



Push button switch, easy control

BUTTON SWITCH WITH VOLUME CONTROL

Manually operated, bi-stable on/off control cartridge for sanitary tapware and technical applications.

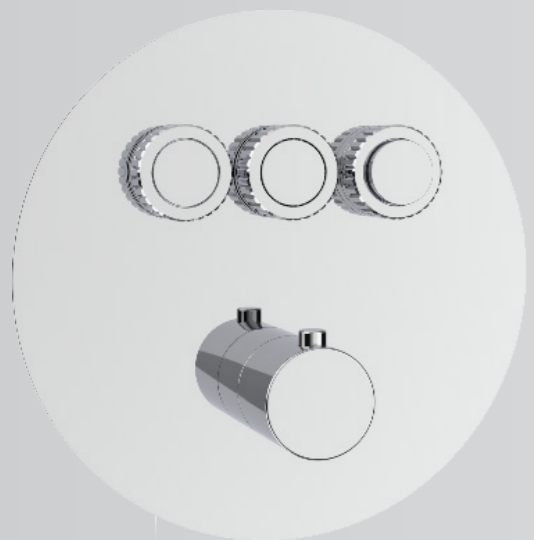

Solid brass casting construction embeded shower valve, long life-time



Manually operated on/off cartridge with precision volume control (range @ 3 bar: ~ 6-30 l/min).



Push button switch with water volume control, easy control



5102-3-CP

Embeded thermostatic shower valve

- 3-way H59 high quality casting brass body, Zinc handle
- Stainless steel 201/304 decoration plate
- Neoperl push-button cartridge
- PPA thermostatic cartridge+Vemet thermostatic sensor
- Finishing: ASS24H, chrome plated, other color optional

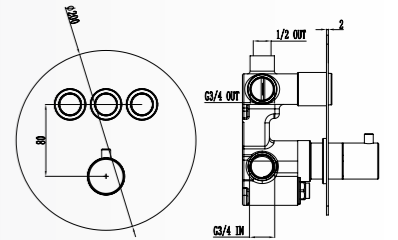

5102-3-MB

Embeded thermostatic shower valve

- 3-way H59 high quality casting brass body, Zinc handle
- Stainless steel 201/304 decoration plate
- Neoperl push-button cartridge
- PPA thermostatic cartridge+Vemet thermostatic sensor
- Finishing: ASS24H, electrophoresis Matte Black, other color optional

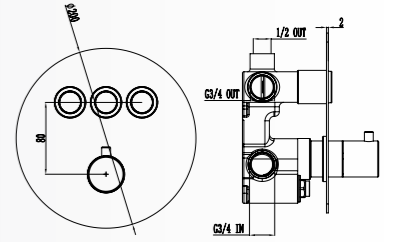

5102-3-BG

Embeded thermostatic shower valve

- 3-way H59 high quality casting brass body, Zinc handle
- Stainless steel 201/304 decoration plate
- Neoperl push-button cartridge
- PPA thermostatic cartridge+Vemet thermostatic sensor
- Finishing: ASS24H, PVD+Nano coating, anti-fingerprint, other color optional

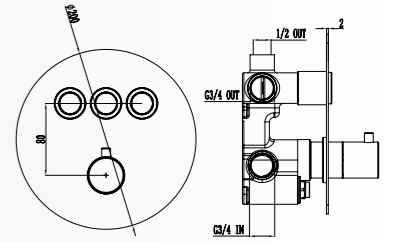

5102F-3-CP

Embeded thermostatic shower valve

- 3-way H59 high quality casting brass body, Zinc handle
- Stainless steel 201/304 decoration plate
- Neoperl push-button cartridge, volume control
- PPA thermostatic cartridge+Vemet thermostatic sensor
- Finishing: ASS24H, chrome plated, other color optional

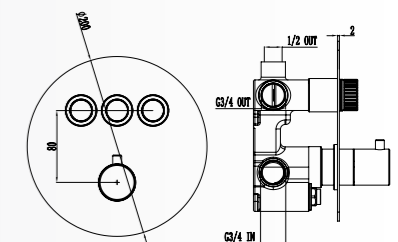

5102F-3-MB

Embeded thermostatic shower valve

- 3-way H59 high quality casting brass body, Zinc handle
- Stainless steel 201/304 decoration plate
- Neoperl push-button cartridge, volume control
- PPA thermostatic cartridge+Vemet thermostatic sensor
- Finishing: ASS24H, electrophoresis Matte Black, other color optional

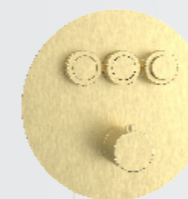
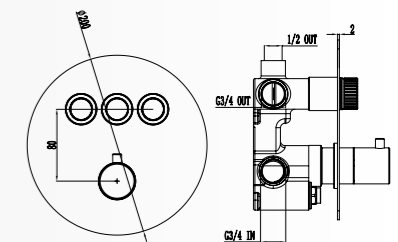

5102F-3-BG

Embeded thermostatic shower valve

- 3-way H59 high quality casting brass body, Zinc handle
- Stainless steel 201/304 decoration plate
- Neoperl push-button cartridge, volume control
- PPA thermostatic cartridge+Vemet thermostatic sensor
- Finishing: ASS24H, PVD+Nano coating, anti-fingerprint, other color optional

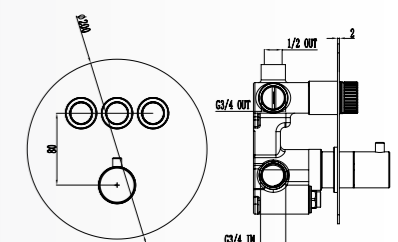

BUTTON SWITCH

Square thermostatic shower valve with Neoperl push-button ON/OFF

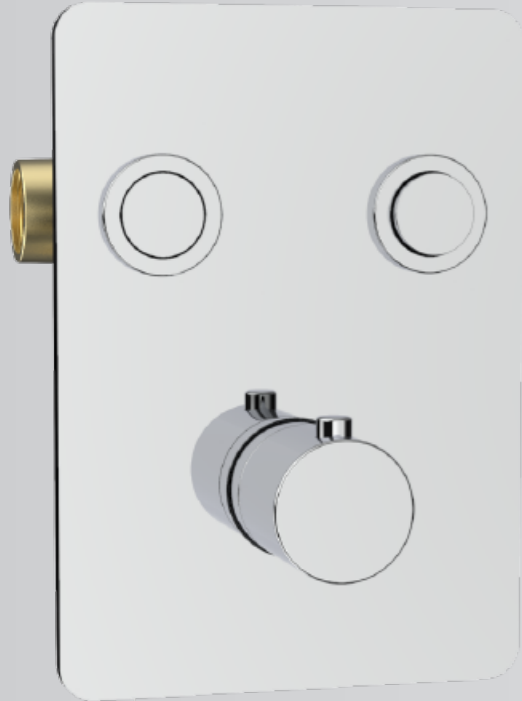

Solid brass casting construction embeded shower valve, long life-time



Manually operated, bi-stable on/off control cartridge for sanitary tapware and technical applications.



Push button switch, easy control

BUTTON SWITCH WITH VOLUME CONTROL

Manually operated, bi-stable on/off control cartridge for sanitary tapware and technical applications.



Solid brass casting construction embeded shower valve, long life-time



Manually operated on/off cartridge with precision volume control (range @ 3 bar: ~ 6-30 l/min).



Push button switch with water volume control, easy control



5103-2-CP

Embeded thermostatic shower valve

- 2-way H59 high quality casting brass body, Zinc handle
- Stainless steel 201/304 decoration plate
- Neoperl push-button cartridge
- PPA thermostatic cartridge+Vemet thermostatic sensor
- Finishing: ASS24H, chrome plated, other color optional

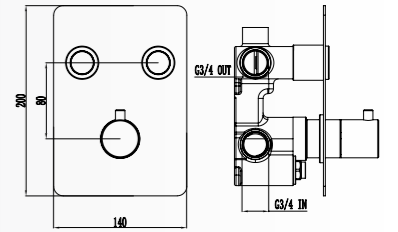

5103-2-MB

Embeded thermostatic shower valve

- 2-way H59 high quality casting brass body, Zinc handle
- Stainless steel 201/304 decoration plate
- Neoperl push-button cartridge
- PPA thermostatic cartridge+Vemet thermostatic sensor
- Finishing: ASS24H, electrophoresis Matte Black, other color optional

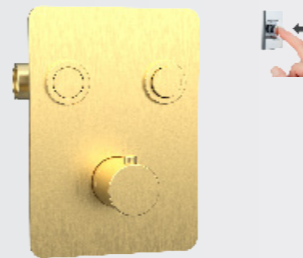
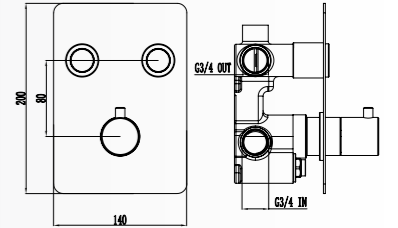

5103-2-BG

Embeded thermostatic shower valve

- 2-way H59 high quality casting brass body, Zinc handle
- Stainless steel 201/304 decoration plate
- Neoperl push-button cartridge
- PPA thermostatic cartridge+Vemet thermostatic sensor
- Finishing: ASS24H, PVD+Nano coating, anti-fingerprint, other color optional

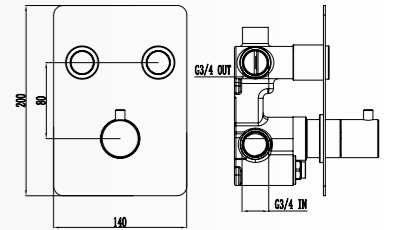

5103F-2-CP

Embeded thermostatic shower valve

- 2-way H59 high quality casting brass body, Zinc handle
- Stainless steel 201/304 decoration plate
- Neoperl push-button cartridge, volume control
- PPA thermostatic cartridge+Vemet thermostatic sensor
- Finishing: ASS24H, chrome plated, other color optional

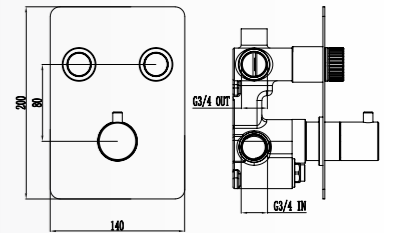

5103F-2-MB

Embeded thermostatic shower valve

- 2-way H59 high quality casting brass body, Zinc handle
- Stainless steel 201/304 decoration plate
- Neoperl push-button cartridge, volume control
- PPA thermostatic cartridge+Vemet thermostatic sensor
- Finishing: ASS24H, electrophoresis Matte Black, other color optional

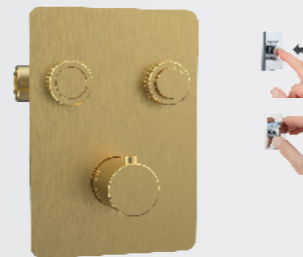
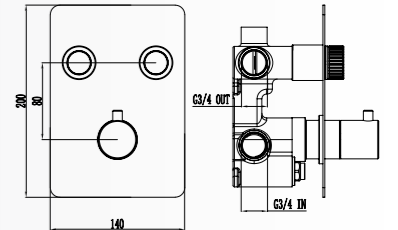

5103F-2-BG

Embeded thermostatic shower valve

- 2-way H59 high quality casting brass body, Zinc handle
- Stainless steel 201/304 decoration plate
- Neoperl push-button cartridge, volume control
- PPA thermostatic cartridge+Vemet thermostatic sensor
- Finishing: ASS24H, PVD+Nano coating, anti-fingerprint, other color optional

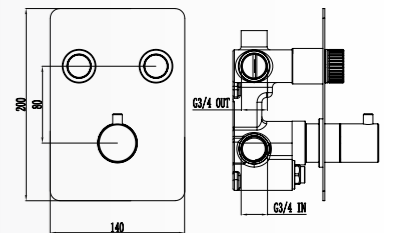

BUTTON SWITCH

Square thermostatic shower valve with Neoperl push-button ON/OFF



Solid brass casting construction embeded shower valve, long life-time



Manually operated, bi-stable on/off control cartridge for sanitary tapware and technical applications.



Push button switch, easy control

BUTTON SWITCH WITH VOLUME CONTROL

Manually operated, bi-stable on/off control cartridge for sanitary tapware and technical applications.



Solid brass casting construction embeded shower valve, long life-time



Manually operated on/off cartridge with precision volume control (range @ 3 bar: ~ 6-30 l/min).



Push button switch with water volume control, easy control



5103-3-CP

Embeded thermostatic shower valve

- 3-way H59 high quality casting brass body, Zinc handle
- Stainless steel 201/304 decoration plate
- Neoperl push-button cartridge
- PPA thermostatic cartridge+Vemet thermostatic sensor
- Finishing: ASS24H, chrome plated, other color optional

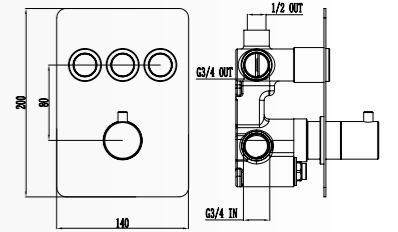

5103-3-MB

Embeded thermostatic shower valve

- 3-way H59 high quality casting brass body, Zinc handle
- Stainless steel 201/304 decoration plate
- Neoperl push-button cartridge
- PPA thermostatic cartridge+Vemet thermostatic sensor
- Finishing: ASS24H, electrophoresis Matte Black, other color optional

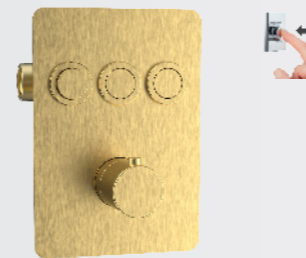
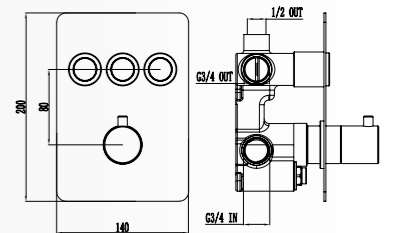

5103-3-BG

Embeded thermostatic shower valve

- 3-way H59 high quality casting brass body, Zinc handle
- Stainless steel 201/304 decoration plate
- Neoperl push-button cartridge
- PPA thermostatic cartridge+Vemet thermostatic sensor
- Finishing: ASS24H, PVD+Nano coating, anti-fingerprint, other color optional

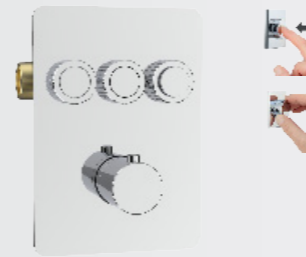
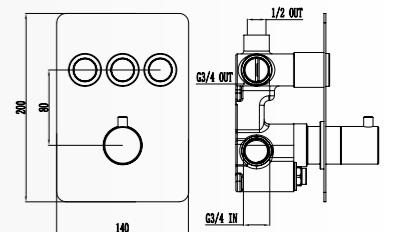

5103F-3-CP

Embeded thermostatic shower valve

- 3-way H59 high quality casting brass body, Zinc handle
- Stainless steel 201/304 decoration plate
- Neoperl push-button cartridge, volume control
- PPA thermostatic cartridge+Vemet thermostatic sensor
- Finishing: ASS24H, chrome plated, other color optional

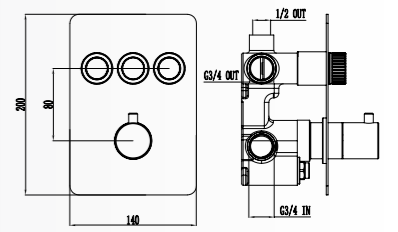

5103F-3-MB

Embeded thermostatic shower valve

- 3-way H59 high quality casting brass body, Zinc handle
- Stainless steel 201/304 decoration plate
- Neoperl push-button cartridge, volume control
- PPA thermostatic cartridge+Vemet thermostatic sensor
- Finishing: ASS24H, electrophoresis Matte Black, other color optional

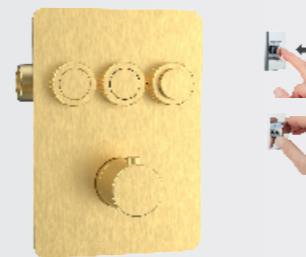
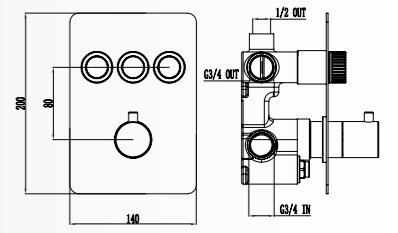

5103F-3-BG

Embeded thermostatic shower valve

- 3-way H59 high quality casting brass body, Zinc handle
- Stainless steel 201/304 decoration plate
- Neoperl push-button cartridge, volume control
- PPA thermostatic cartridge+Vemet thermostatic sensor
- Finishing: ASS24H, PVD+Nano coating, anti-fingerprint, other color optional

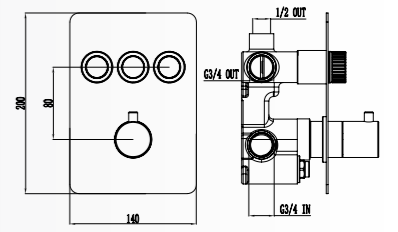

EMBEDED THERMOSTATIC VALVE

Manually operated, bi-stable on/off control cartridge for sanitary tapware and technical applications.

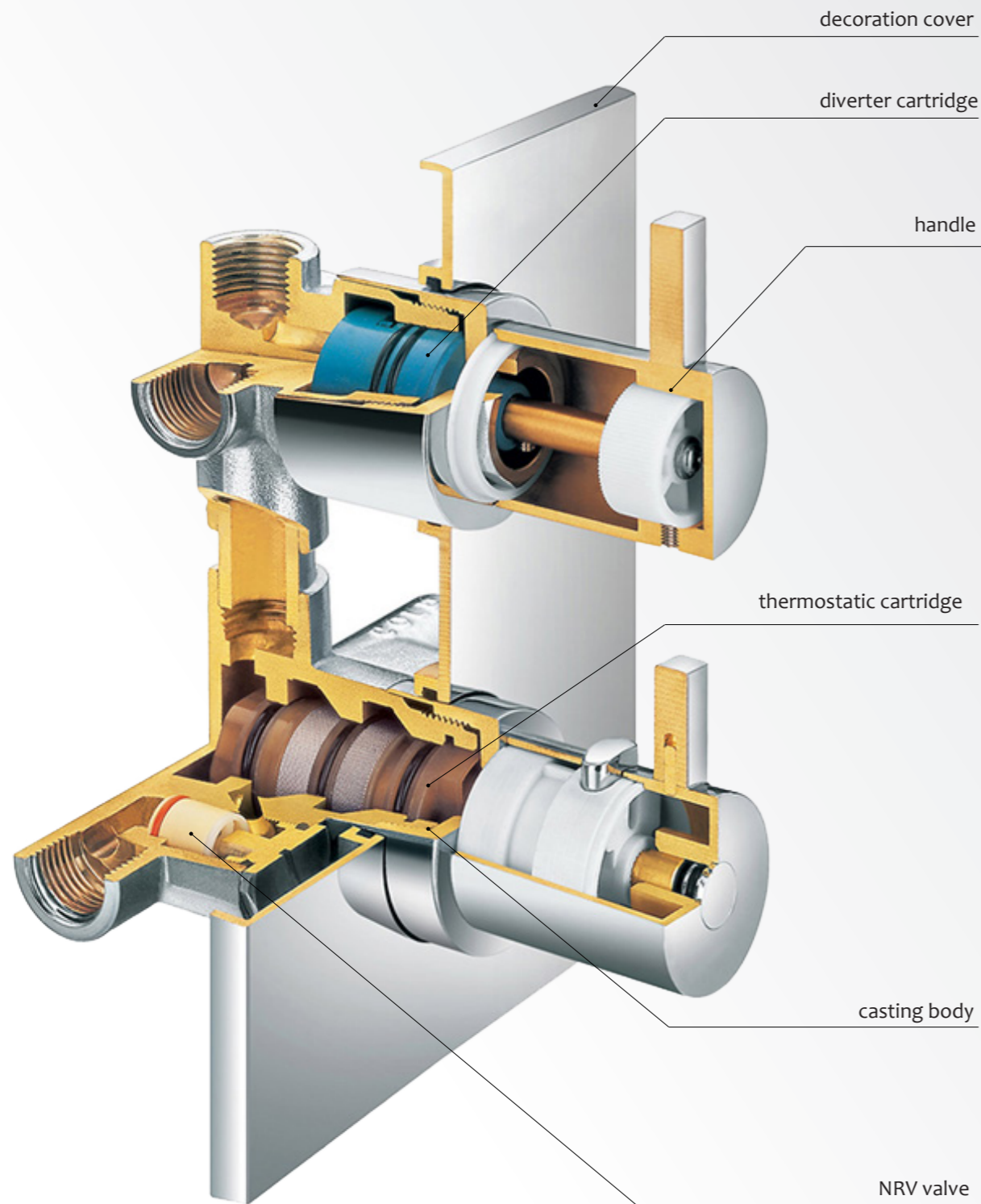

NORMAL SWITCH



THE NEW TECHNOLOGY FROM YUSON



Technical Characteristics

- Materials: POM, PPS, PPE, EPDM (elastomers), stainless steel (springs)
- Designed to comply with sanitary tapware performance standards, e.g. EN817 and ASME A112.18.1
- Materials in water contact comply with international drinking water certifications

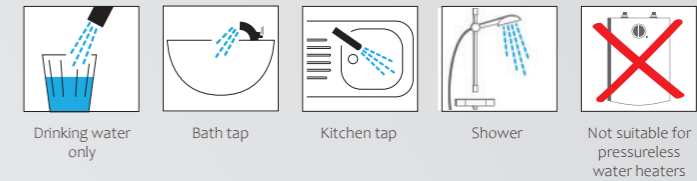

Technical Characteristics

- Materials: POM, PPS, PPE, EPDM (elastomers), stainless steel (springs)
- Designed to comply with sanitary tapware performance standards, e.g. EN817 and ASME A112.18.1
- materials in water contact comply with international drinking water certifications

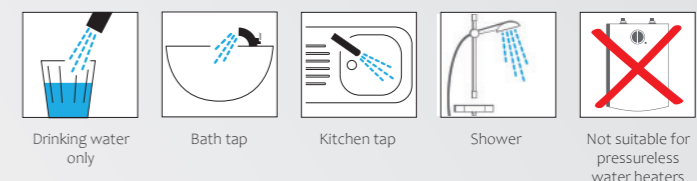



5104-1-MB

Embedded thermostatic shower valve

- 1-way H59 high quality casting brass body, Zinc handle
- Stainless steel 201/304 decoration plate
- Ceramic diverter cartridge
- PPA thermostatic cartridge+Vemet thermostatic element
- Finishing: ASS24H, matte black, other color optional

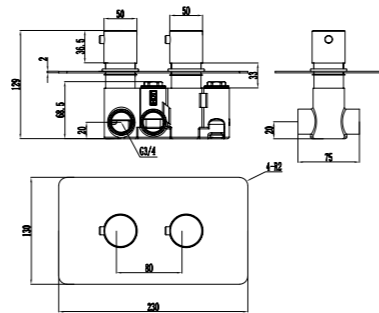

5105B-1-MB

Embedded thermostatic shower valve

- 1-way H59 high quality casting brass body, Zinc handle
- Stainless steel 201/304 decoration plate
- Ceramic diverter cartridge
- PPA thermostatic cartridge+Vemet thermostatic element
- Finishing: ASS24H, matte black, other color optional

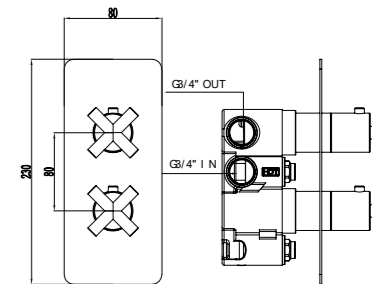

5104-2-MB

Embedded thermostatic shower valve

- 2-way H59 high quality casting brass body, Zinc handle
- Stainless steel 201/304 decoration plate
- Ceramic diverter cartridge
- PPA thermostatic cartridge+Vemet thermostatic element
- Finishing: ASS24H, matte black, other color optional

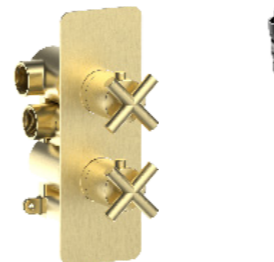
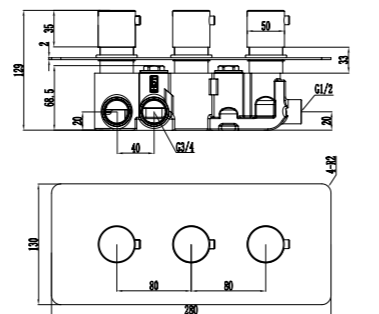

5105B-1-BG

Embedded thermostatic shower valve

- 1-way H59 high quality casting brass body, Zinc handle
- Stainless steel 201/304 decoration plate
- Ceramic diverter cartridge
- PPA thermostatic cartridge+Vemet thermostatic element
- Finishing: ASS24H, PVD brushed gold, other color optional

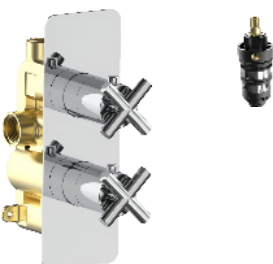
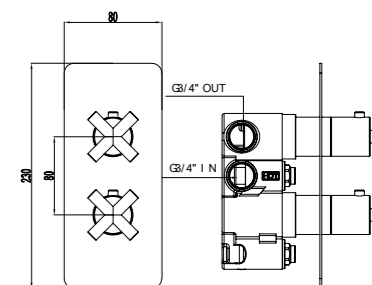

5105A-1-CP

Embedded thermostatic shower valve

- 1-way H59 high quality casting brass body, Zinc handle
- Stainless steel 201/304 decoration plate
- Ceramic diverter cartridge
- PPA thermostatic cartridge+Vemet thermostatic element
- Finishing: ASS24H, chrome plated, other color optional

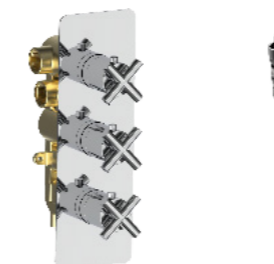
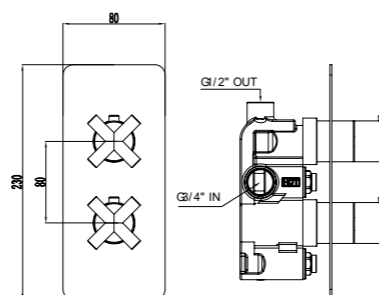

5105A-2-CP

Embedded thermostatic shower valve

- 2-way H59 high quality casting brass body, Zinc handle
- Stainless steel 201/304 decoration plate
- Ceramic diverter cartridge
- PPA thermostatic cartridge+Vemet thermostatic element
- Finishing: ASS24H, chrome plated, other color optional

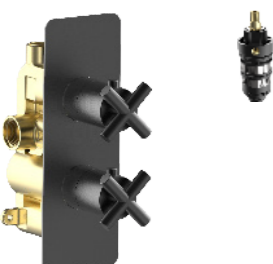
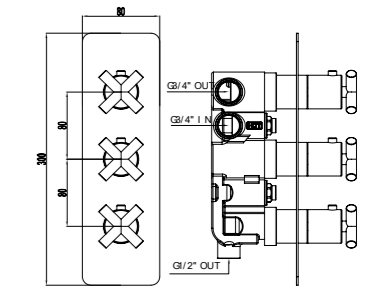

5105A-1-MB

Embedded thermostatic shower valve

- 1-way H59 high quality casting brass body, Zinc handle
- Stainless steel 201/304 decoration plate
- Ceramic diverter cartridge
- PPA thermostatic cartridge+Vemet thermostatic element
- Finishing: ASS24H, matte black, other color optional

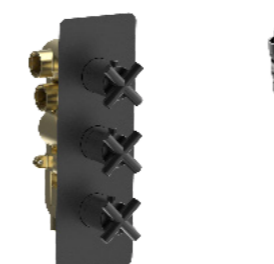
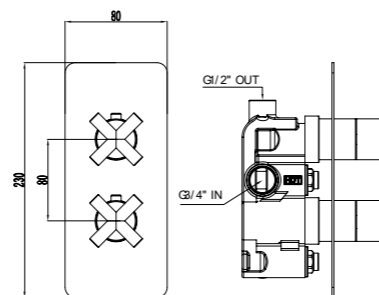

5105A-2-MB

Embedded thermostatic shower valve

- 2-way H59 high quality casting brass body, Zinc handle
- Stainless steel 201/304 decoration plate
- Ceramic diverter cartridge
- PPA thermostatic cartridge+Vemet thermostatic element
- Finishing: ASS24H, matte black, other color optional

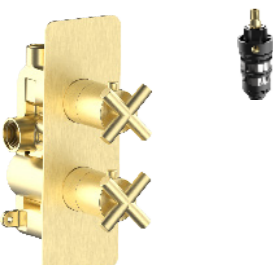
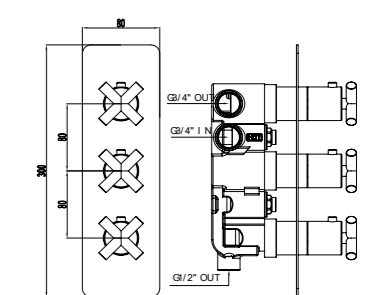

5105A-1-BG

Embedded thermostatic shower valve

- 1-way H59 high quality casting brass body, Zinc handle
- Stainless steel 201/304 decoration plate
- Ceramic diverter cartridge
- PPA thermostatic cartridge+Vemet thermostatic element
- Finishing: ASS24H, PVD brushed gold, other color optional

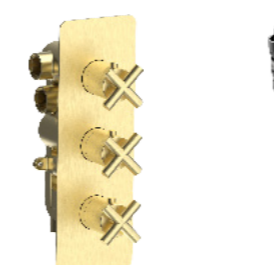
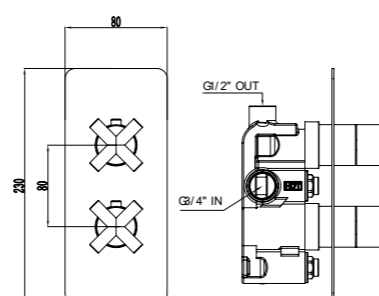

5105A-2-BG

Embedded thermostatic shower valve

- 2-way H59 high quality casting brass body, Zinc handle
- Stainless steel 201/304 decoration plate
- Ceramic diverter cartridge
- PPA thermostatic cartridge+Vemet thermostatic element
- Finishing: ASS24H, PVD brushed gold, other color optional

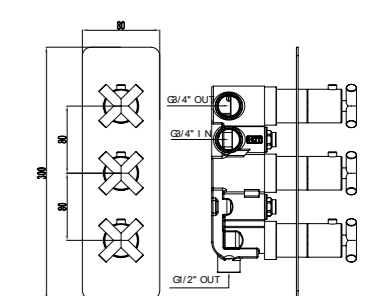

5105B-1-CP

Embedded thermostatic shower valve

- 1-way H59 high quality casting brass body, Zinc handle
- Stainless steel 201/304 decoration plate
- Ceramic diverter cartridge
- PPA thermostatic cartridge+Vemet thermostatic element
- Finishing: ASS24H, chrome plated, other color optional

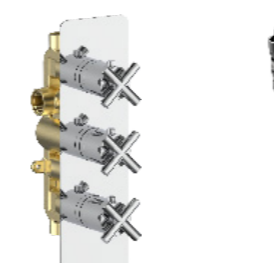
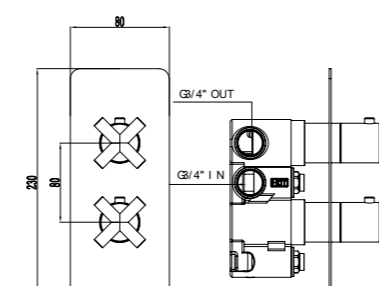

5105B-2-CP

Embedded thermostatic shower valve

- 2-way H59 high quality casting brass body, Zinc handle
- Stainless steel 201/304 decoration plate
- Ceramic diverter cartridge
- PPA thermostatic cartridge+Vemet thermostatic element
- Finishing: ASS24H, chrome plated, other color optional

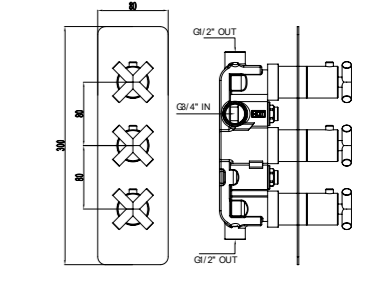

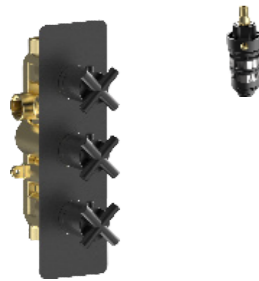

5105B-2-MB

Embedded thermostatic shower valve

- 2-way H59 high quality casting brass body, Zinc handle
- Stainless steel 201/304 decoration plate
- Ceramic diverter cartridge
- PPA thermostatic cartridge+Vemet thermostatic element
- Finishing: ASS24H, matte black, other color optional

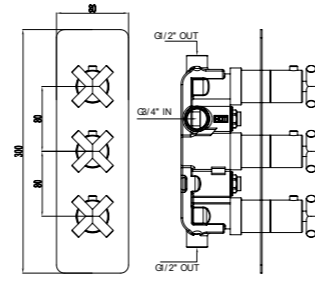

5106B-1-MB

Embedded thermostatic shower valve

- 1-way H59 high quality casting brass body, Zinc handle
- Stainless steel 201/304 decoration plate
- Ceramic diverter cartridge
- PPA thermostatic cartridge+Vemet thermostatic element
- Finishing: ASS24H, matte black, other color optional

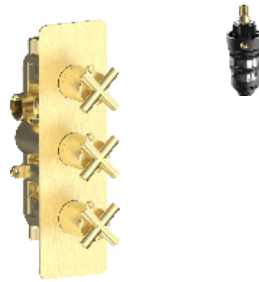
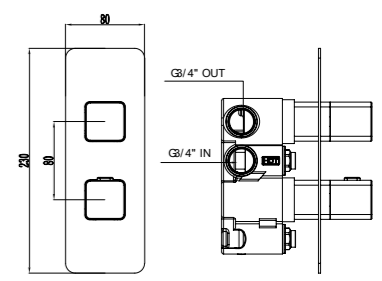

5105B-2-BG

Embedded thermostatic shower valve

- 2-way H59 high quality casting brass body, Zinc handle
- Stainless steel 201/304 decoration plate
- Ceramic diverter cartridge
- PPA thermostatic cartridge+Vemet thermostatic element
- Finishing: ASS24H, PVD brushed gold, other color optional

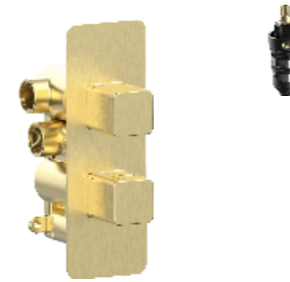
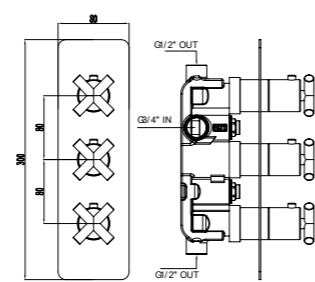

5106B-1-BG

Embedded thermostatic shower valve

- 1-way H59 high quality casting brass body, Zinc handle
- Stainless steel 201/304 decoration plate
- Ceramic diverter cartridge
- PPA thermostatic cartridge+Vemet thermostatic element
- Finishing: ASS24H, PVD brushed gold, other color optional

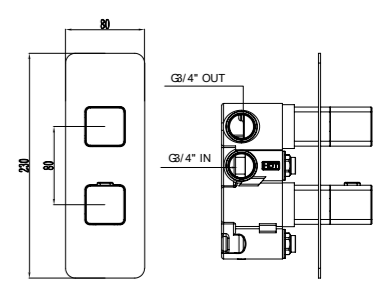

5106A-1-CP

Embedded thermostatic shower valve

- 1-way H59 high quality casting brass body, Zinc handle
- Stainless steel 201/304 decoration plate
- Ceramic diverter cartridge
- PPA thermostatic cartridge+Vemet thermostatic element
- Finishing: ASS24H, chrome plated, other color optional

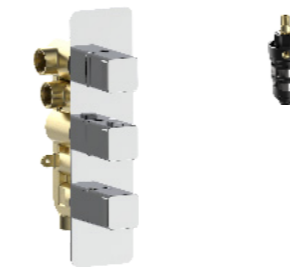
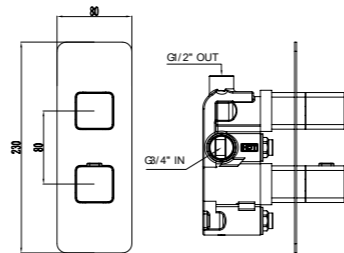

5106A-2-CP

Embedded thermostatic shower valve

- 2-way H59 high quality casting brass body, Zinc handle
- Stainless steel 201/304 decoration plate
- Ceramic diverter cartridge
- PPA thermostatic cartridge+Vemet thermostatic element
- Finishing: ASS24H, chrome plated, other color optional

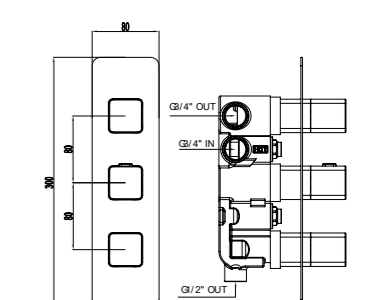

5106A-1-MB

Embedded thermostatic shower valve

- 1-way H59 high quality casting brass body, Zinc handle
- Stainless steel 201/304 decoration plate
- Ceramic diverter cartridge
- PPA thermostatic cartridge+Vemet thermostatic element
- Finishing: ASS24H, matte black, other color optional

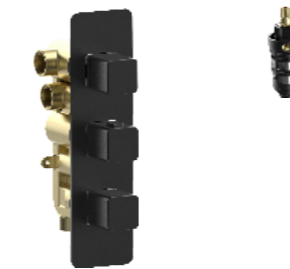
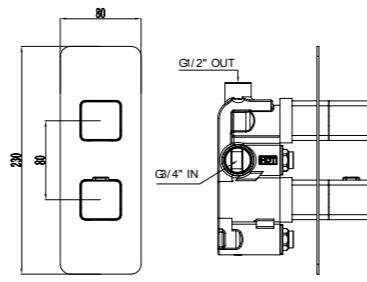

5106A-2-MB

Embedded thermostatic shower valve

- 2-way H59 high quality casting brass body, Zinc handle
- Stainless steel 201/304 decoration plate
- Ceramic diverter cartridge
- PPA thermostatic cartridge+Vemet thermostatic element
- Finishing: ASS24H, matte black, other color optional

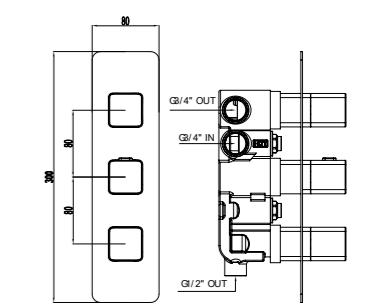

5106A-1-BG

Embedded thermostatic shower valve

- 1-way H59 high quality casting brass body, Zinc handle
- Stainless steel 201/304 decoration plate
- Ceramic diverter cartridge
- PPA thermostatic cartridge+Vemet thermostatic element
- Finishing: ASS24H, PVD brushed gold, other color optional

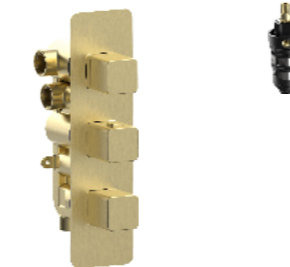
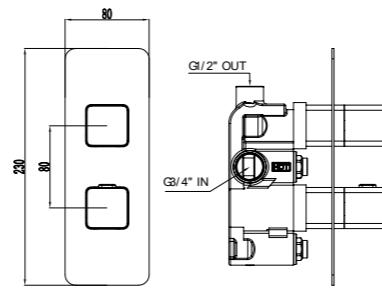

5106A-2-BG

Embedded thermostatic shower valve

- 2-way H59 high quality casting brass body, Zinc handle
- Stainless steel 201/304 decoration plate
- Ceramic diverter cartridge
- PPA thermostatic cartridge+Vemet thermostatic element
- Finishing: ASS24H, PVD brushed gold, other color optional

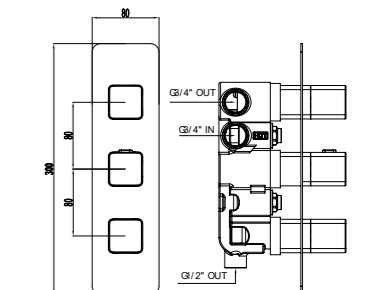

5106B-1-CP

Embedded thermostatic shower valve

- 1-way H59 high quality casting brass body, Zinc handle
- Stainless steel 201/304 decoration plate
- Ceramic diverter cartridge
- PPA thermostatic cartridge+Vemet thermostatic element
- Finishing: ASS24H, chrome plated, other color optional

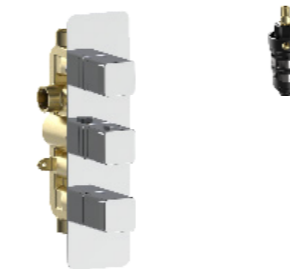
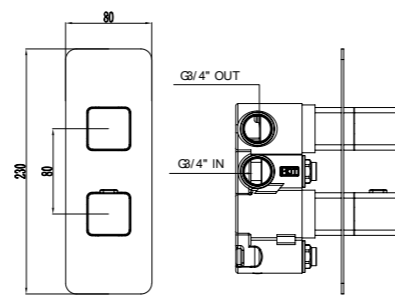

5106B-2-CP

Embedded thermostatic shower valve

- 2-way H59 high quality casting brass body, Zinc handle
- Stainless steel 201/304 decoration plate
- Ceramic diverter cartridge
- PPA thermostatic cartridge+Vemet thermostatic element
- Finishing: ASS24H, chrome plated, other color optional

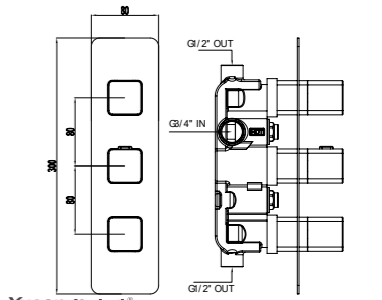

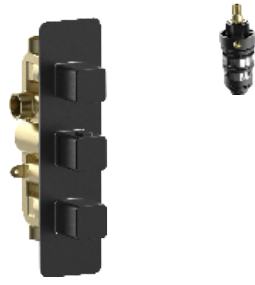

5106B-2-MB

Embedded thermostatic shower valve

- 2-way H59 high quality casting brass body, Zinc handle
- Stainless steel 201/304 decoration plate
- Ceramic diverter cartridge
- PPA thermostatic cartridge+Vemet thermostatic element
- Finishing: ASS24H, matte black, other color optional

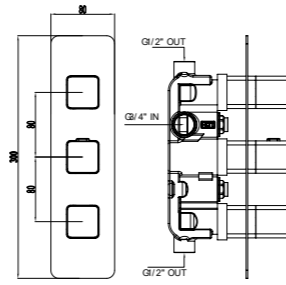

5107B-1-MB

Embedded thermostatic shower valve

- 1-way H59 high quality casting brass body, Zinc handle
- Stainless steel 201/304 decoration plate
- Ceramic diverter cartridge
- PPA thermostatic cartridge+Vemet thermostatic element
- Finishing: ASS24H, matte black, other color optional

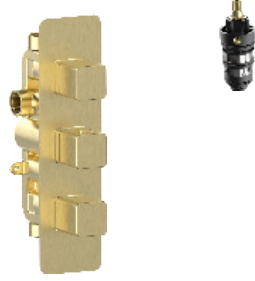
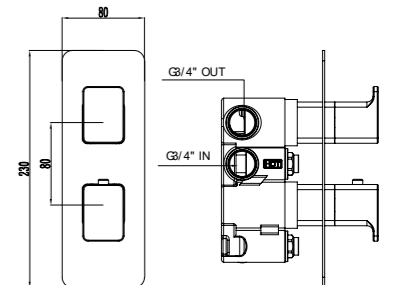

5106B-2-BG

Embedded thermostatic shower valve

- 2-way H59 high quality casting brass body, Zinc handle
- Stainless steel 201/304 decoration plate
- Ceramic diverter cartridge
- PPA thermostatic cartridge+Vemet thermostatic element
- Finishing: ASS24H, PVD brushed gold, other color optional

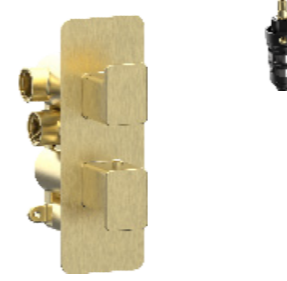
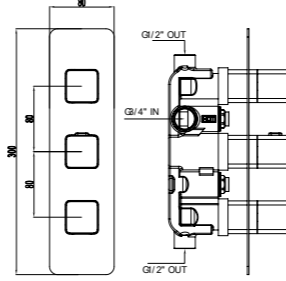

5107B-1-BG

Embedded thermostatic shower valve

- 1-way H59 high quality casting brass body, Zinc handle
- Stainless steel 201/304 decoration plate
- Ceramic diverter cartridge
- PPA thermostatic cartridge+Vemet thermostatic element
- Finishing: ASS24H, PVD brushed gold, other color optional

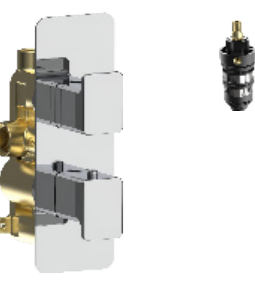
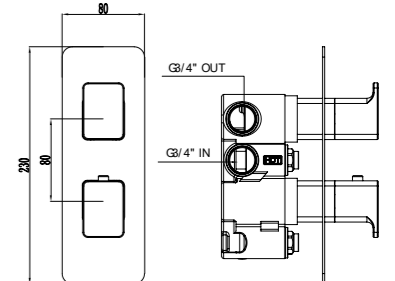

5107A-1-CP

Embedded thermostatic shower valve

- 1-way H59 high quality casting brass body, Zinc handle
- Stainless steel 201/304 decoration plate
- Ceramic diverter cartridge
- PPA thermostatic cartridge+Vemet thermostatic element
- Finishing: ASS24H, chrome plated, other color optional

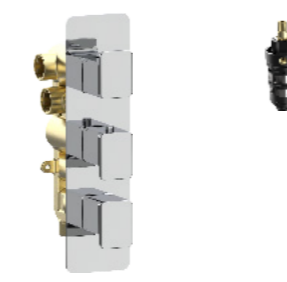
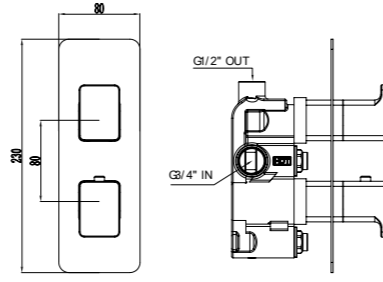

5107A-2-CP

Embedded thermostatic shower valve

- 2-way H59 high quality casting brass body, Zinc handle
- Stainless steel 201/304 decoration plate
- Ceramic diverter cartridge
- PPA thermostatic cartridge+Vemet thermostatic element
- Finishing: ASS24H, chrome plated, other color optional

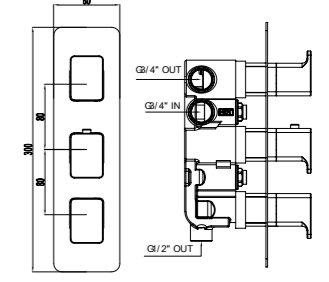

5107A-1-MB

Embedded thermostatic shower valve

- 1-way H59 high quality casting brass body, Zinc handle
- Stainless steel 201/304 decoration plate
- Ceramic diverter cartridge
- PPA thermostatic cartridge+Vemet thermostatic element
- Finishing: ASS24H, matte black, other color optional

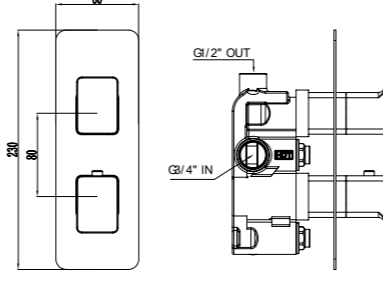

5107A-2-MB

Embedded thermostatic shower valve

- 2-way H59 high quality casting brass body, Zinc handle
- Stainless steel 201/304 decoration plate
- Ceramic diverter cartridge
- PPA thermostatic cartridge+Vemet thermostatic element
- Finishing: ASS24H, matte black, other color optional

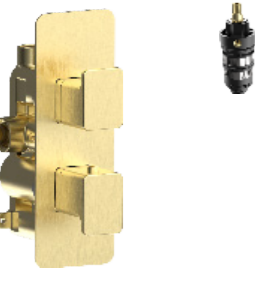
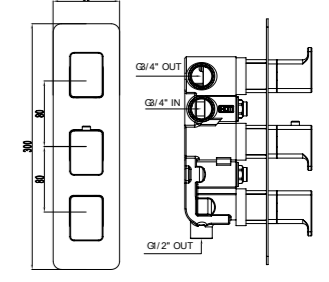

5107A-1-BG

Embedded thermostatic shower valve

- 1-way H59 high quality casting brass body, Zinc handle
- Stainless steel 201/304 decoration plate
- Ceramic diverter cartridge
- PPA thermostatic cartridge+Vemet thermostatic element
- Finishing: ASS24H, PVD brushed gold, other color optional

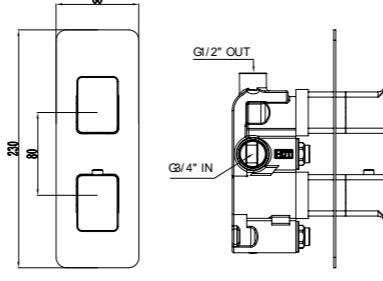

5107A-2-BG

Embedded thermostatic shower valve

- 2-way H59 high quality casting brass body, Zinc handle
- Stainless steel 201/304 decoration plate
- Ceramic diverter cartridge
- PPA thermostatic cartridge+Vemet thermostatic element
- Finishing: ASS24H, PVD brushed gold, other color optional

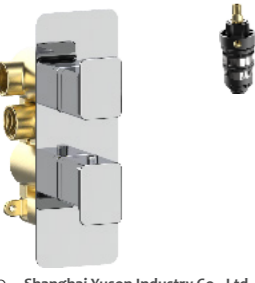
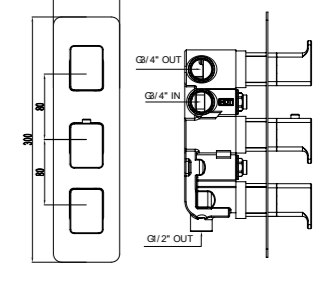

5107B-1-CP

Embedded thermostatic shower valve

- 1-way H59 high quality casting brass body, Zinc handle
- Stainless steel 201/304 decoration plate
- Ceramic diverter cartridge
- PPA thermostatic cartridge+Vemet thermostatic element
- Finishing: ASS24H, chrome plated, other color optional

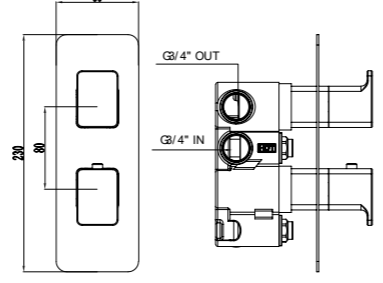

5107B-2-CP

Embedded thermostatic shower valve

- 2-way H59 high quality casting brass body, Zinc handle
- Stainless steel 201/304 decoration plate
- Ceramic diverter cartridge
- PPA thermostatic cartridge+Vemet thermostatic element
- Finishing: ASS24H, chrome plated, other color optional

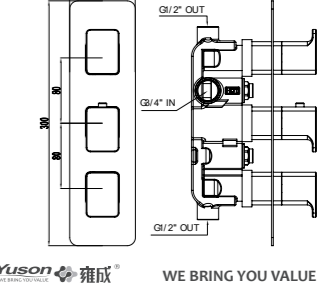



5107B-2-MB

Embedded thermostatic shower valve

- 2-way H59 high quality casting brass body, Zinc handle
- Stainless steel 201/304 decoration plate
- Ceramic diverter cartridge
- PPA thermostatic cartridge+Vemet thermostatic element
- Finishing: ASS24H, matte black, other color optional

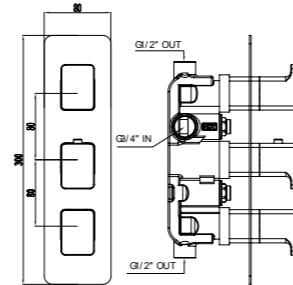

5108B-1-MB

Embedded thermostatic shower valve

- 1-way H59 high quality casting brass body, Zinc handle
- Stainless steel 201/304 decoration plate
- Ceramic diverter cartridge
- PPA thermostatic cartridge+Vemet thermostatic element
- Finishing: ASS24H, matte black, other color optional

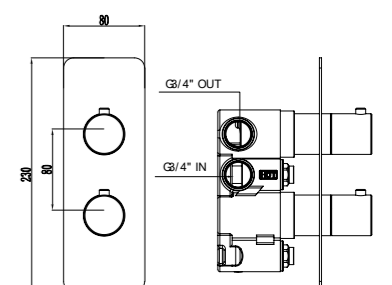

5107B-2-BG

Embedded thermostatic shower valve

- 2-way H59 high quality casting brass body, Zinc handle
- Stainless steel 201/304 decoration plate
- Ceramic diverter cartridge
- PPA thermostatic cartridge+Vemet thermostatic element
- Finishing: ASS24H, PVD brushed gold, other color optional

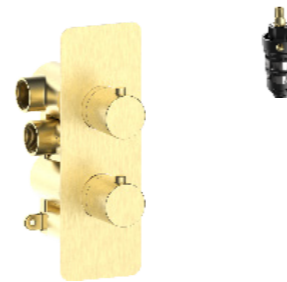
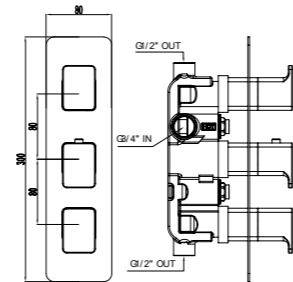

5108B-1-BG

Embedded thermostatic shower valve

- 1-way H59 high quality casting brass body, Zinc handle
- Stainless steel 201/304 decoration plate
- Ceramic diverter cartridge
- PPA thermostatic cartridge+Vemet thermostatic element
- Finishing: ASS24H, PVD brushed gold, other color optional

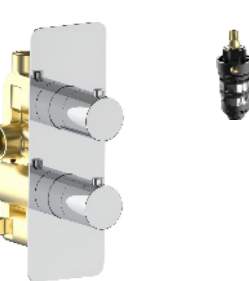
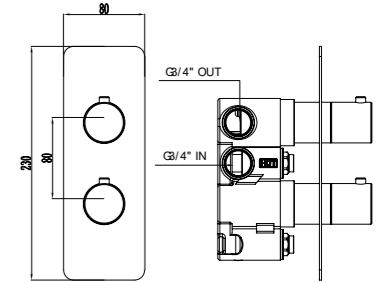

5108A-1-CP

Embedded thermostatic shower valve

- 1-way H59 high quality casting brass body, Zinc handle
- Stainless steel 201/304 decoration plate
- Ceramic diverter cartridge
- PPA thermostatic cartridge+Vemet thermostatic element
- Finishing: ASS24H, chrome plated, other color optional

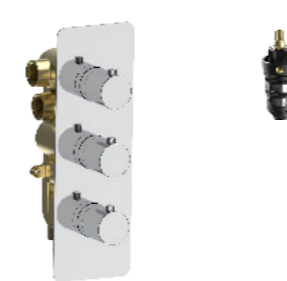
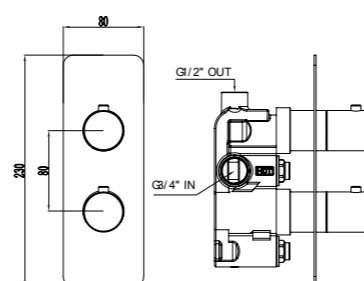

5108A-2-CP

Embedded thermostatic shower valve

- 2-way H59 high quality casting brass body, Zinc handle
- Stainless steel 201/304 decoration plate
- Ceramic diverter cartridge
- PPA thermostatic cartridge+Vemet thermostatic element
- Finishing: ASS24H, chrome plated, other color optional

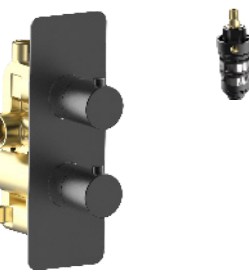
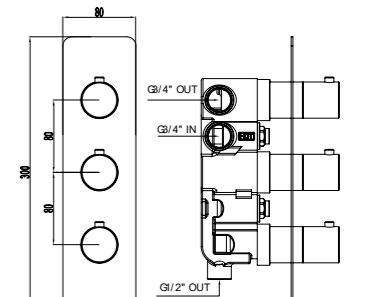

5108A-1-MB

Embedded thermostatic shower valve

- 1-way H59 high quality casting brass body, Zinc handle
- Stainless steel 201/304 decoration plate
- Ceramic diverter cartridge
- PPA thermostatic cartridge+Vemet thermostatic element
- Finishing: ASS24H, matte black, other color optional

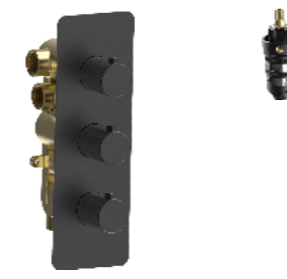
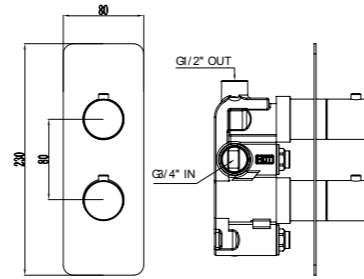

5108A-2-MB

Embedded thermostatic shower valve

- 2-way H59 high quality casting brass body, Zinc handle
- Stainless steel 201/304 decoration plate
- Ceramic diverter cartridge
- PPA thermostatic cartridge+Vemet thermostatic element
- Finishing: ASS24H, matte black, other color optional

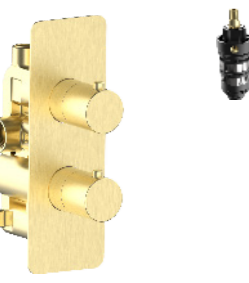
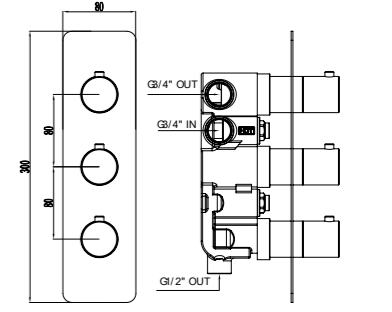

5108A-1-BG

Embedded thermostatic shower valve

- 1-way H59 high quality casting brass body, Zinc handle
- Stainless steel 201/304 decoration plate
- Ceramic diverter cartridge
- PPA thermostatic cartridge+Vemet thermostatic element
- Finishing: ASS24H, PVD brushed gold, other color optional

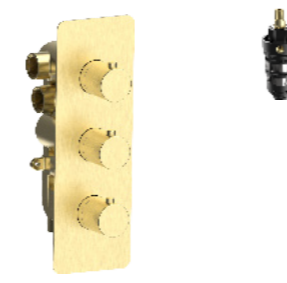
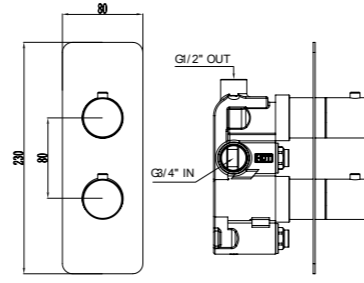

5108A-2-BG

Embedded thermostatic shower valve

- 2-way H59 high quality casting brass body, Zinc handle
- Stainless steel 201/304 decoration plate
- Ceramic diverter cartridge
- PPA thermostatic cartridge+Vemet thermostatic element
- Finishing: ASS24H, PVD brushed gold, other color optional

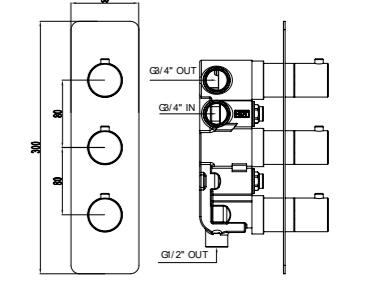

5108B-1-CP

Embedded thermostatic shower valve

- 1-way H59 high quality casting brass body, Zinc handle
- Stainless steel 201/304 decoration plate
- Ceramic diverter cartridge
- PPA thermostatic cartridge+Vemet thermostatic element
- Finishing: ASS24H, chrome plated, other color optional

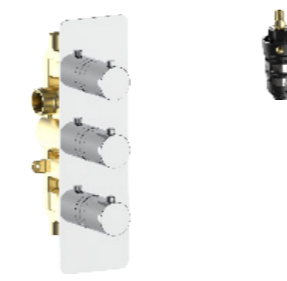
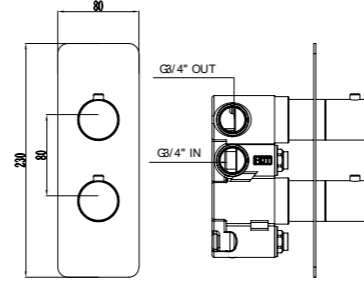

5108B-2-CP

Embedded thermostatic shower valve

- 2-way H59 high quality casting brass body, Zinc handle
- Stainless steel 201/304 decoration plate
- Ceramic diverter cartridge
- PPA thermostatic cartridge+Vemet thermostatic element
- Finishing: ASS24H, chrome plated, other color optional

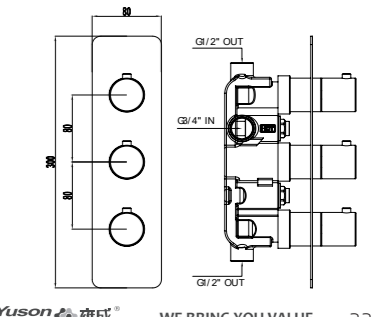

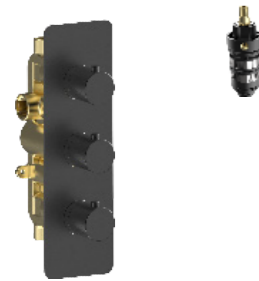

5108B-2-MB

Embedded thermostatic shower valve

- 2-way H59 high quality casting brass body, Zinc handle
- Stainless steel 201/304 decoration plate
- Ceramic diverter cartridge
- PPA thermostatic cartridge+Vemet thermostatic element
- Finishing: ASS24H, matte black, other color optional

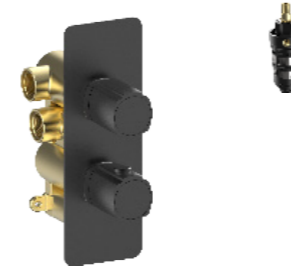
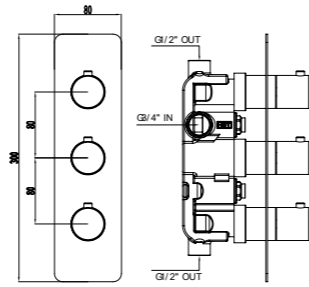

5109B-1-MB

Embedded thermostatic shower valve

- 1-way H59 high quality casting brass body, Zinc handle
- Stainless steel 201/304 decoration plate
- Ceramic diverter cartridge
- PPA thermostatic cartridge+Vemet thermostatic element
- Finishing: ASS24H, matte black, other color optional

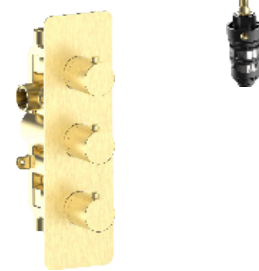
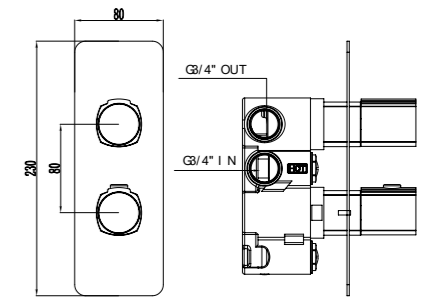

5108B-2-BG

Embedded thermostatic shower valve

- 2-way H59 high quality casting brass body, Zinc handle
- Stainless steel 201/304 decoration plate
- Ceramic diverter cartridge
- PPA thermostatic cartridge+Vemet thermostatic element
- Finishing: ASS24H, PVD brushed gold, other color optional

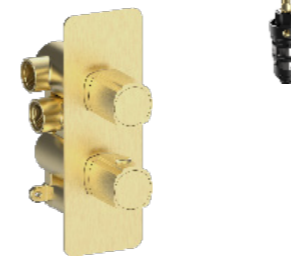
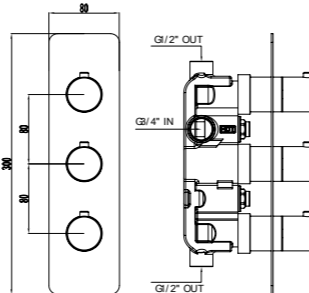

5109B-1-BG

Embedded thermostatic shower valve

- 1-way H59 high quality casting brass body, Zinc handle
- Stainless steel 201/304 decoration plate
- Ceramic diverter cartridge
- PPA thermostatic cartridge+Vemet thermostatic element
- Finishing: ASS24H, PVD brushed gold, other color optional

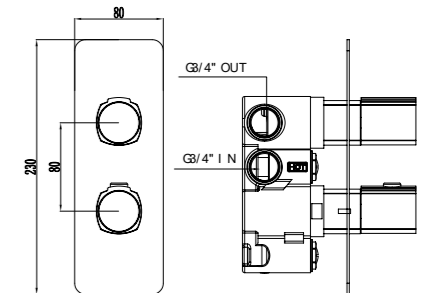

5109A-1-CP

Embedded thermostatic shower valve

- 1-way H59 high quality casting brass body, Zinc handle
- Stainless steel 201/304 decoration plate
- Ceramic diverter cartridge
- PPA thermostatic cartridge+Vemet thermostatic element
- Finishing: ASS24H, chrome plated, other color optional

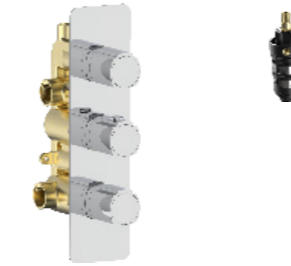
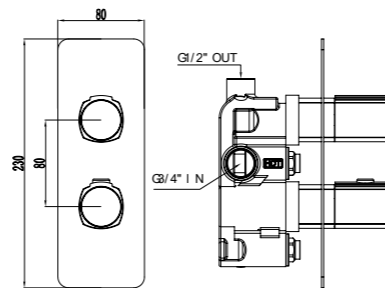

5109A-2-CP

Embedded thermostatic shower valve

- 2-way H59 high quality casting brass body, Zinc handle
- Stainless steel 201/304 decoration plate
- Ceramic diverter cartridge
- PPA thermostatic cartridge+Vemet thermostatic element
- Finishing: ASS24H, chrome plated, other color optional

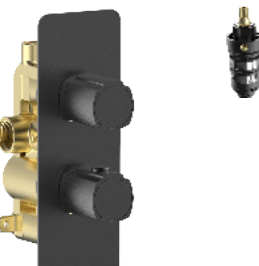
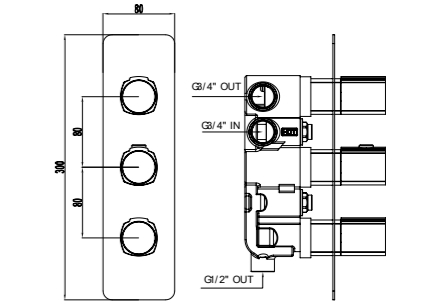

5109A-1-MB

Embedded thermostatic shower valve

- 1-way H59 high quality casting brass body, Zinc handle
- Stainless steel 201/304 decoration plate
- Ceramic diverter cartridge
- PPA thermostatic cartridge+Vemet thermostatic element
- Finishing: ASS24H, matte black, other color optional

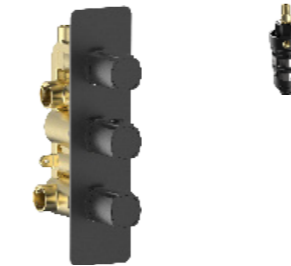
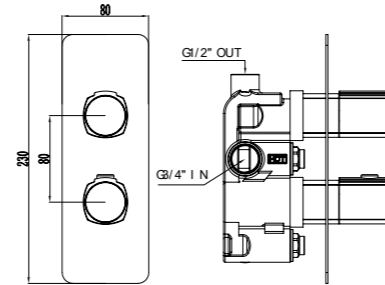

5109A-2-MB

Embedded thermostatic shower valve

- 2-way H59 high quality casting brass body, Zinc handle
- Stainless steel 201/304 decoration plate
- Ceramic diverter cartridge
- PPA thermostatic cartridge+Vemet thermostatic element
- Finishing: ASS24H, matte black, other color optional

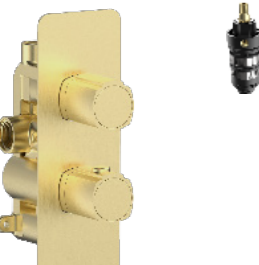
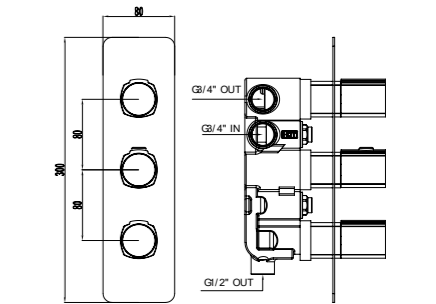

5109A-1-BG

Embedded thermostatic shower valve

- 1-way H59 high quality casting brass body, Zinc handle
- Stainless steel 201/304 decoration plate
- Ceramic diverter cartridge
- PPA thermostatic cartridge+Vemet thermostatic element
- Finishing: ASS24H, PVD brushed gold, other color optional

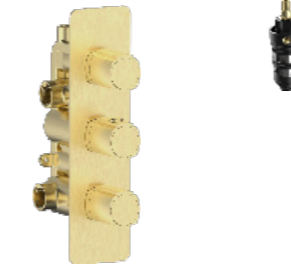
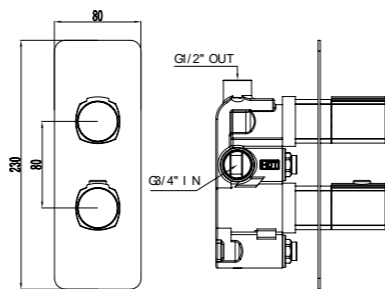

5109A-2-BG

Embedded thermostatic shower valve

- 2-way H59 high quality casting brass body, Zinc handle
- Stainless steel 201/304 decoration plate
- Ceramic diverter cartridge
- PPA thermostatic cartridge+Vemet thermostatic element
- Finishing: ASS24H, PVD brushed gold, other color optional

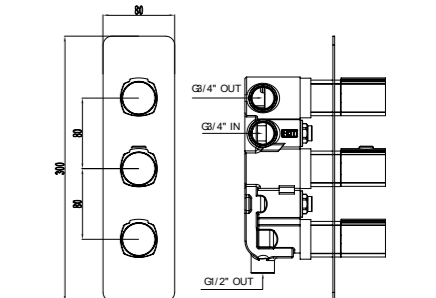

5109B-1-CP

Embedded thermostatic shower valve

- 1-way H59 high quality casting brass body, Zinc handle
- Stainless steel 201/304 decoration plate
- Ceramic diverter cartridge
- PPA thermostatic cartridge+Vemet thermostatic element
- Finishing: ASS24H, chrome plated, other color optional

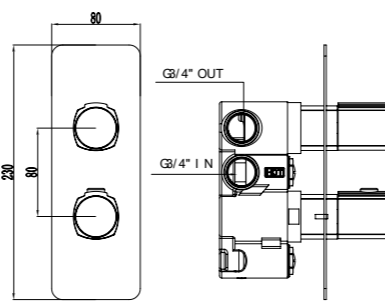

5109B-2-CP

Embedded thermostatic shower valve

- 2-way H59 high quality casting brass body, Zinc handle
- Stainless steel 201/304 decoration plate
- Ceramic diverter cartridge
- PPA thermostatic cartridge+Vemet thermostatic element
- Finishing: ASS24H, chrome plated, other color optional

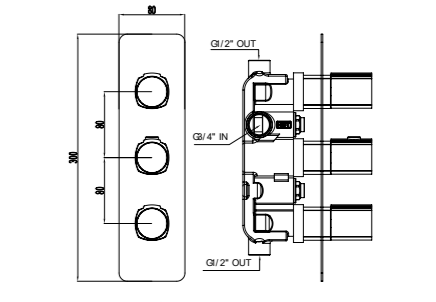



5109B-2-MB

Embedded thermostatic shower valve

- 2-way H59 high quality casting brass body, Zinc handle
- Stainless steel 201/304 decoration plate
- Ceramic diverter cartridge
- PPA thermostatic cartridge+Vemet thermostatic element
- Finishing: ASS24H, matte black, other color optional

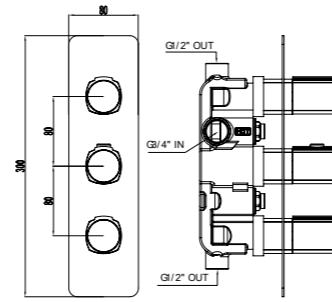

5109B-2-BG

Embedded thermostatic shower valve

- 2-way H59 high quality casting brass body, Zinc handle
- Stainless steel 201/304 decoration plate
- Ceramic diverter cartridge
- PPA thermostatic cartridge+Vemet thermostatic element
- Finishing: ASS24H, PVD brushed gold, other color optional

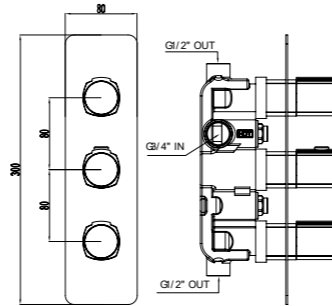

NORMAL SWITCH



RELIABLE THERMOSTATIC VALVE

Manually operated, bi-stable on/off control cartridge for sanitary tapware and technical applications.



Technical Characteristics

- Materials: POM, PPS, PPE, EPDM (elastomers), stainless steel (springs)
- Designed to comply with sanitary tapware performance standards, e.g. EN817 and ASME A112.18.1
- Materials in water contact comply with international drinking water certifications

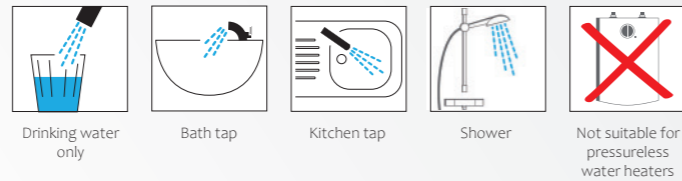

Technical Characteristics

- Materials: POM, PPS, PPE, EPDM (elastomers), stainless steel (springs)
- Designed to comply with sanitary tapware performance standards, e.g. EN817 and ASME A112.18.1
- Materials in water contact comply with international drinking water certifications



COOL-TOUCH



THE NEW COOL-TOUCH TECHNOLOGY

Manually operated, bi-stable on/off control cartridge for sanitary tapware and technical applications.

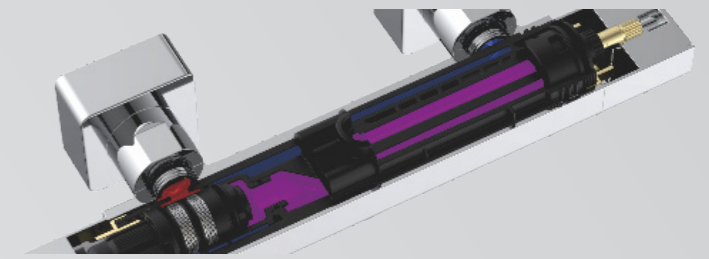

Technical Characteristics

- Materials: POM, PPS, PPE, EPDM (elastomers), stainless steel (springs)
- Designed to comply with sanitary tapware performance standards, e.g. EN817 and ASME A112.18.1
- materials in water contact comply with international drinking water certifications

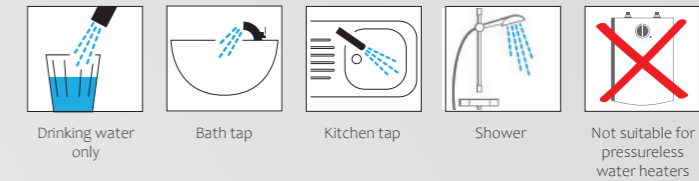

Technical Characteristics

- Materials: POM, PPS, PPE, EPDM (elastomers), stainless steel (springs)
- Designed to comply with sanitary tapware performance standards, e.g. EN817 and ASME A112.18.1
- materials in water contact comply with international drinking water certifications

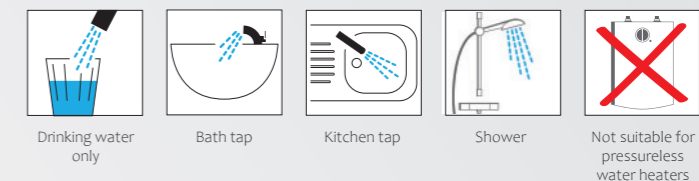

BUTTON SWITCH WITH VOLUME CONTROL

Round thermostatic shower valve with Neoperl push-button ON/OFF and volume control



Manually operated on/off cartridge with precision volume control (range @ 3 bar: ~ 6-30 l/min).

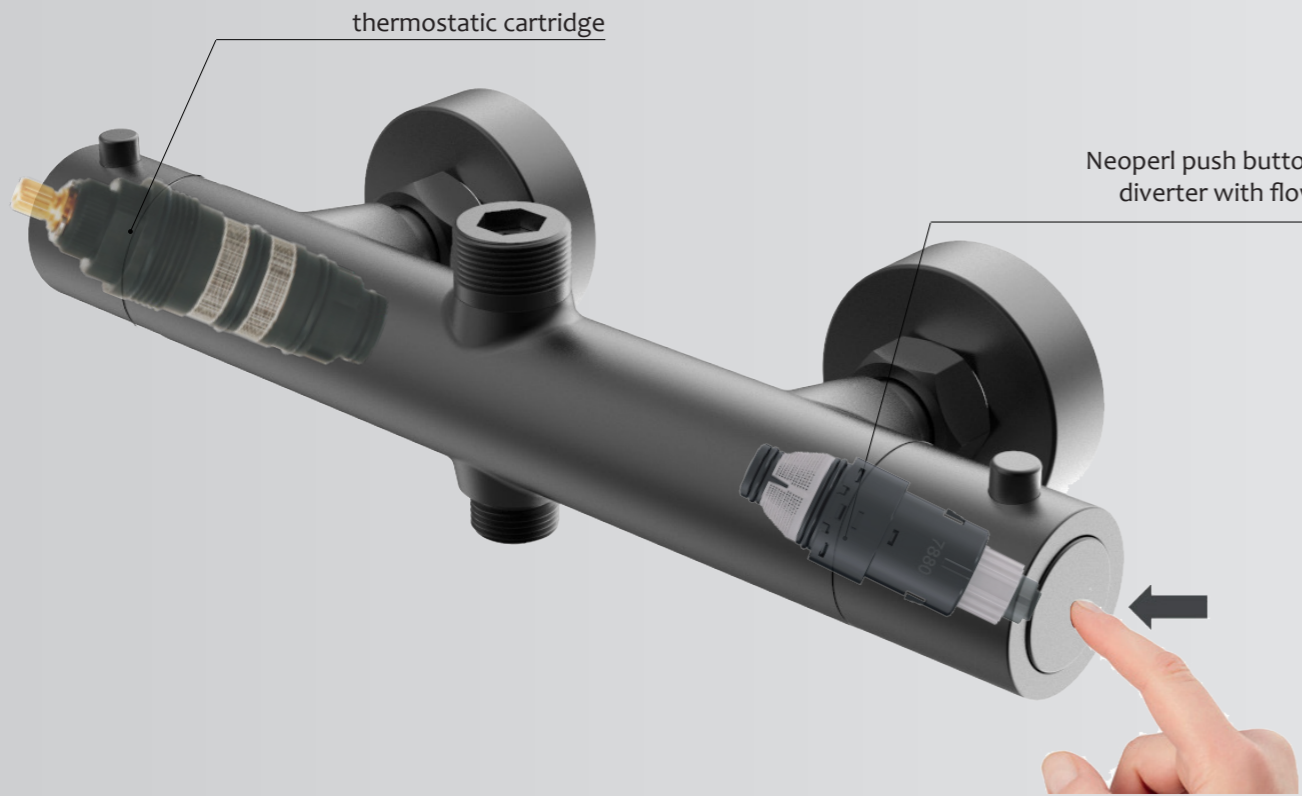

Benefits :

- >Precise thermostatic regulation
- >Long life expectancy
- >Stable mixed outlet water
- >Geometry to meet international standards
- >Preset temperature function
- >Easy ON/OFF



5108A-1-CP

Push button thermostatic shower faucet

- 2-way H59 high quality casting brass body, Zinc handle
- Neoperl push-button cartridge, volume control
- PPA thermostatic cartridge+Vemet thermostatic sensor
- Finishing: ASS24H, chrome plated, other color optional

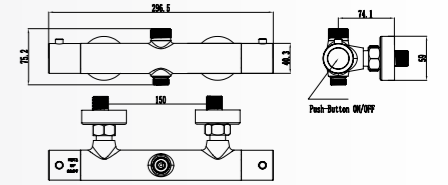

5108A-1-MB

Push button thermostatic shower faucet

- 2-way H59 high quality casting brass body, Zinc handle
- Neoperl push-button cartridge, volume control
- PPA thermostatic cartridge+Vemet thermostatic sensor
- Finishing: ASS24H, electrophoresis Matte Black, other color optional

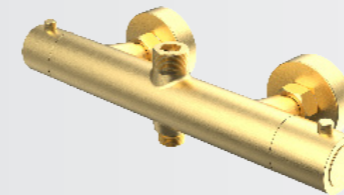
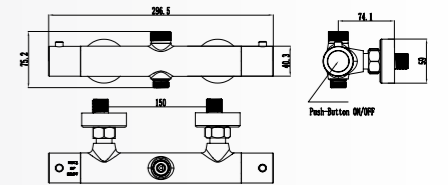

5108A-1-BG

Push button thermostatic shower faucet

- 2-way H59 high quality casting brass body, Zinc handle
- Neoperl push-button cartridge, volume control
- PPA thermostatic cartridge+Vemet thermostatic sensor
- Finishing: ASS24H, PVD brushed gold, other color optional

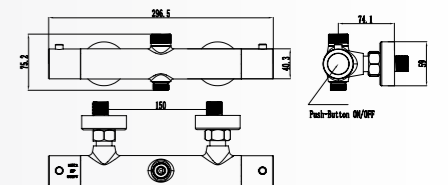

5040-22-CP

Cool-touch thermostatic shower faucet

- 2-way H59 high quality casting brass body, ABS handle
- Stainless steel 201/304 decoration plate
- Ceramic diverter cartridge
- PPA thermostatic cartridge+Vemet thermostatic element
- Finishing: ASS24H, chrome plated, other color optional

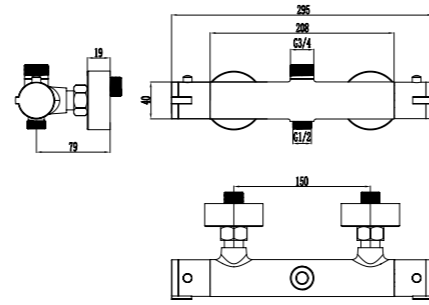

5041-21-CP

Cool-touch thermostatic shower faucet

- 2-way H59 high quality casting brass body, Zinc handle
- Ceramic diverter cartridge
- PPA thermostatic cartridge+Vemet thermostatic element
- Finishing: ASS24H, chrome plated, other color optional

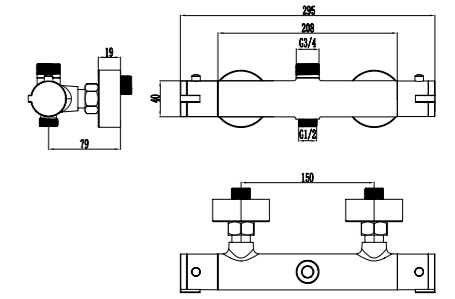

5040-22-MB

Cool-touch thermostatic shower faucet

- 2-way H59 high quality casting brass body, ABS handle
- Ceramic diverter cartridge
- PPA thermostatic cartridge+Vemet thermostatic element
- Finishing: ASS24H, matte black, other color optional

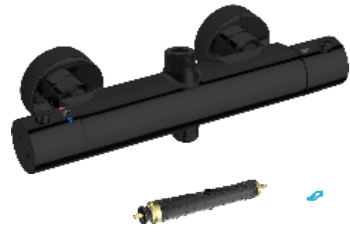
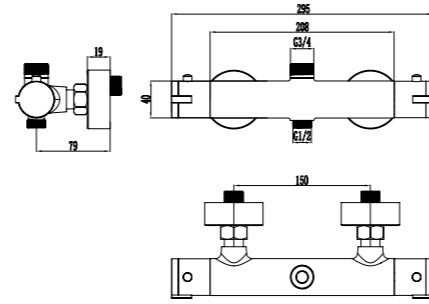

5041-21-MB

Cool-touch thermostatic shower faucet

- 2-way H59 high quality casting brass body, Zinc handle
- Ceramic diverter cartridge
- PPA thermostatic cartridge+Vemet thermostatic element
- Finishing: ASS24H, matte black, other color optional

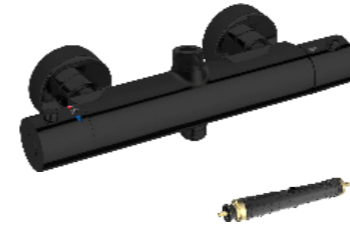
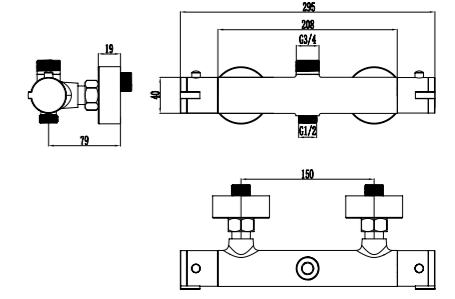

5040-22-BG

Cool-touch thermostatic shower faucet

- 2-way H59 high quality casting brass body, ABS handle
- Ceramic diverter cartridge
- PPA thermostatic cartridge+Vemet thermostatic element
- Finishing: ASS24H, PVD brush gold, other color optional

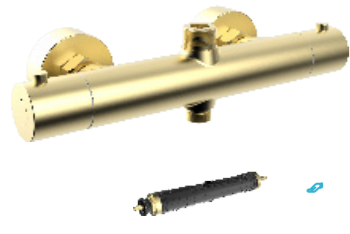
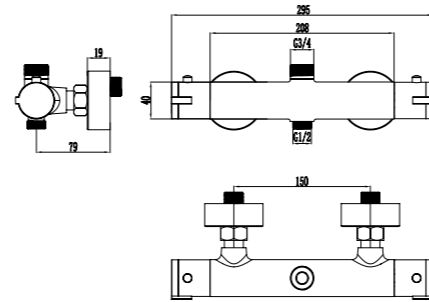

5041-21-BG

Cool-touch thermostatic shower faucet

- 2-way H59 high quality casting brass body, Zinc handle
- Ceramic diverter cartridge
- PPA thermostatic cartridge+Vemet thermostatic element
- Finishing: ASS24H, PVD brush gold, other color optional

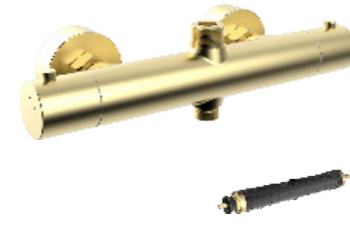
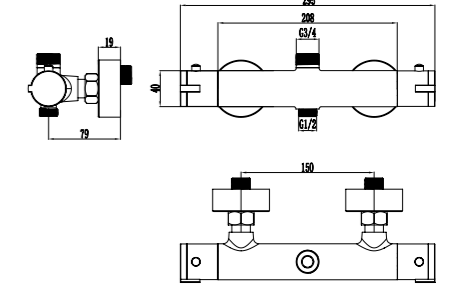

5041-10-CP

Cool-touch thermostatic shower faucet

- 2-way H59 high quality casting brass body, Zinc handle
- Ceramic diverter cartridge
- PPA thermostatic cartridge+Vemet thermostatic element
- Finishing: ASS24H, chrome plated, other color optional

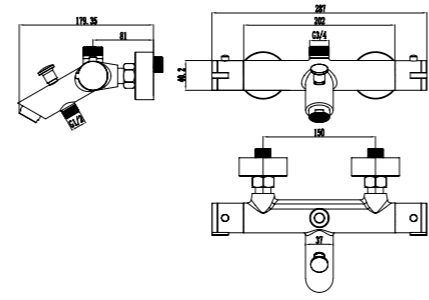

5042-22-CP

Cool-touch thermostatic shower faucet

- 2-way H59 high quality casting brass body, Zinc handle
- Ceramic diverter cartridge
- PPA thermostatic cartridge+Vemet thermostatic element
- Finishing: ASS24H, chrome plated, other color optional

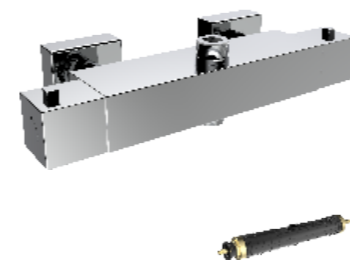
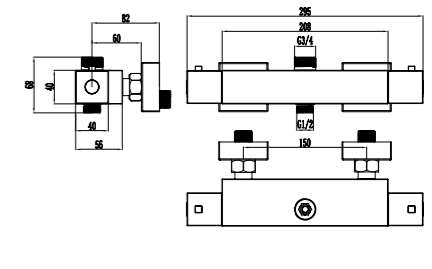

5041-10-MB

Cool-touch thermostatic shower faucet

- 2-way H59 high quality casting brass body, Zinc handle
- Ceramic diverter cartridge
- PPA thermostatic cartridge+Vemet thermostatic element
- Finishing: ASS24H, matte black, other color optional

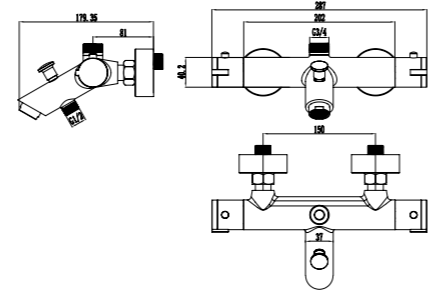

5042-22-MB

Cool-touch thermostatic shower faucet

- 2-way H59 high quality casting brass body, Zinc handle
- Ceramic diverter cartridge
- PPA thermostatic cartridge+Vemet thermostatic element
- Finishing: ASS24H, matte black, other color optional

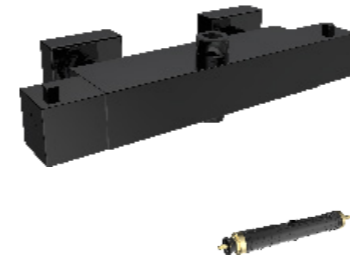
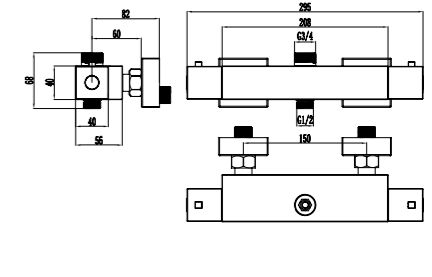

5041-10-BG

Cool-touch thermostatic shower faucet

- 2-way H59 high quality casting brass body, Zinc handle
- Ceramic diverter cartridge
- PPA thermostatic cartridge+Vemet thermostatic element
- Finishing: ASS24H, PVD brush gold, other color optional

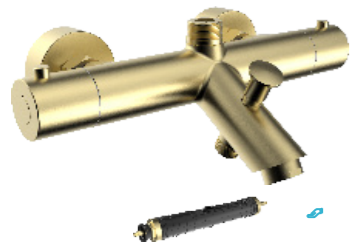
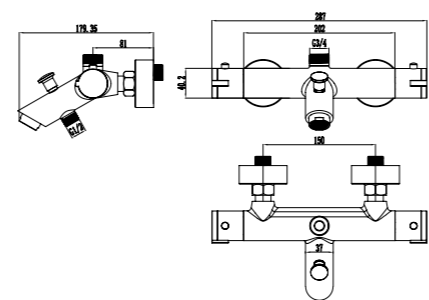

5042-22-BG

Cool-touch thermostatic shower faucet

- 2-way H59 high quality casting brass body, Zinc handle
- Ceramic diverter cartridge
- PPA thermostatic cartridge+Vemet thermostatic element
- Finishing: ASS24H, PVD brush gold, other color optional

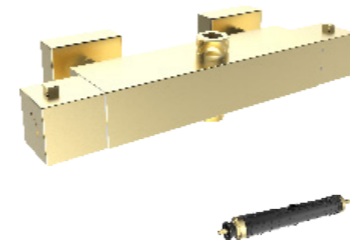
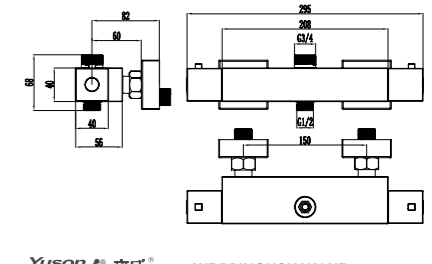



5003-11-CP

Thermostatic shower faucet

- 2-way H59 high quality casting brass body, Zinc handle
- Ceramic diverter cartridge
- PPA thermostatic cartridge+Vernet thermostatic element
- Finishing: ASS24H, PVD brush gold, other color optional

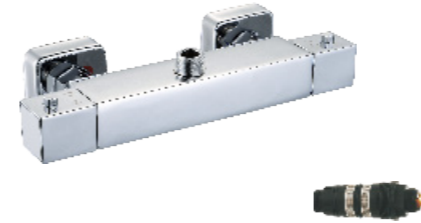
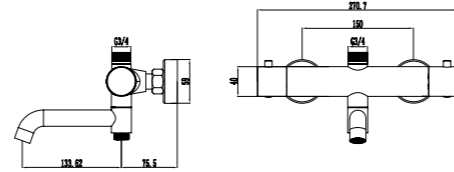

5004-21-CP

Thermostatic shower faucet

- 1-way H59 high quality casting brass body, Zinc handle
- Ceramic diverter cartridge
- PPA thermostatic cartridge+Vernet thermostatic element
- Finishing: ASS24H, PVD brush gold, other color optional

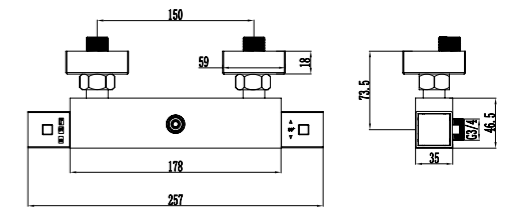

5003-10-CP

Thermostatic shower faucet

- 2-way H59 high quality casting brass body, Zinc handle
- Ceramic diverter cartridge
- PPA thermostatic cartridge+Vernet thermostatic element
- Finishing: ASS24H, PVD brush gold, other color optional

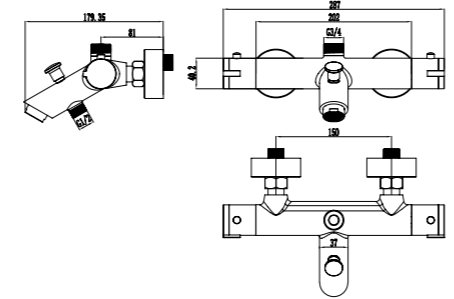

5004-22-CP

Thermostatic shower faucet

- 2-way H59 high quality casting brass body, Zinc handle
- Ceramic diverter cartridge
- PPA thermostatic cartridge+Vernet thermostatic element
- Finishing: ASS24H, PVD brush gold, other color optional

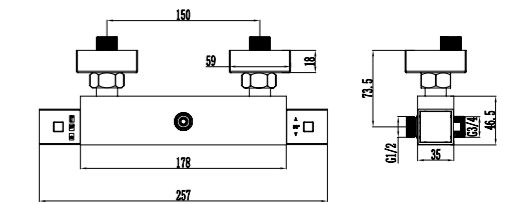

5003-20-CP

Thermostatic shower faucet

- 1-way H59 high quality casting brass body, Zinc handle
- Ceramic diverter cartridge
- PPA thermostatic cartridge+Vernet thermostatic element
- Finishing: ASS24H, PVD brush gold, other color optional

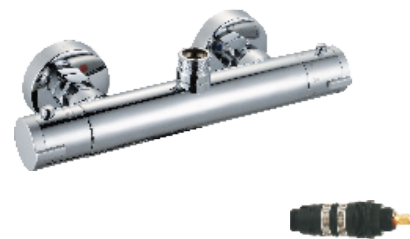
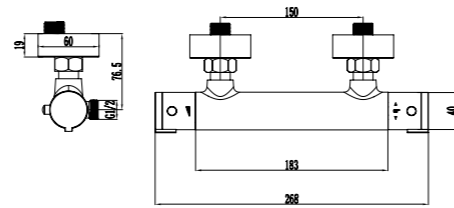

5003-21-CP

Thermostatic shower faucet

- 1-way H59 high quality casting brass body, Zinc handle
- Ceramic diverter cartridge
- PPA thermostatic cartridge+Vernet thermostatic element
- Finishing: ASS24H, PVD brush gold, other color optional

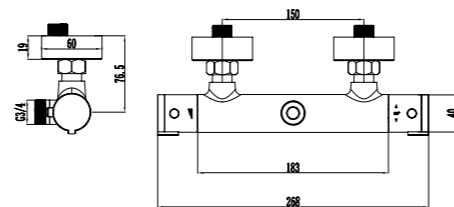

5003-22-CP

Thermostatic shower faucet

- 2-way H59 high quality casting brass body, Zinc handle
- Ceramic diverter cartridge
- PPA thermostatic cartridge+Vernet thermostatic element
- Finishing: ASS24H, PVD brush gold, other color optional

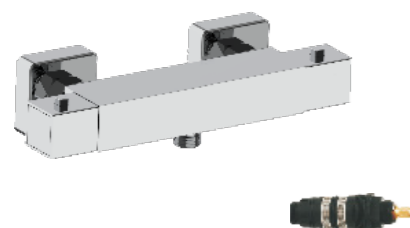
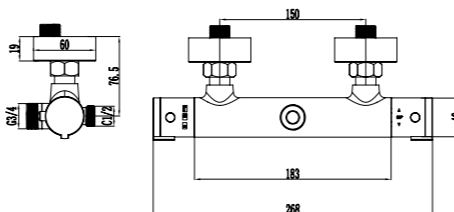

5004-20-CP

Thermostatic shower faucet

- 1-way H59 high quality casting brass body, Zinc handle
- Ceramic diverter cartridge
- PPA thermostatic cartridge+Vernet thermostatic element
- Finishing: ASS24H, PVD brush gold, other color optional

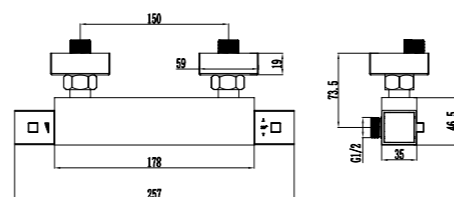

VINTAGE DESIGN THERMOSTATIC SHOWER VALVE

Round thermostatic shower valve with vintage design



Technical Characteristics

- Materials: POM, PPS, PPE, EPDM (elastomers), stainless steel (springs)
- Designed to comply with sanitary tapware performance standards, e.g. EN817 and ASME A112.18.1
- Materials in water contact comply with international drinking water certifications

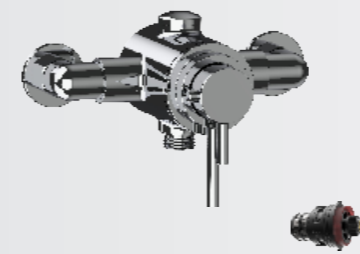
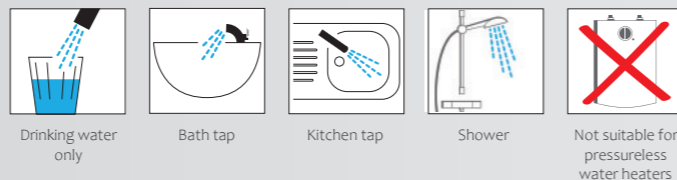

5019-20-CP

Vintage thermostatic shower valve

- 1-way H59 high quality casting brass body, Zinc handle
- PPA thermostatic cartridge+Vemet thermostatic sensor
- Finishing: ASS24H, chrome plated, other color optional

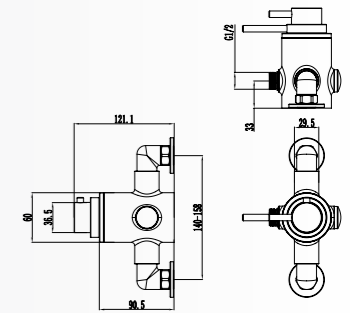

5019-20-MB

Push button thermostatic shower faucet

- 1-way H59 high quality casting brass body, Zinc handle
- PPA thermostatic cartridge+Vemet thermostatic sensor
- Finishing: ASS24H, electrophoresis Matte Black, other color optional

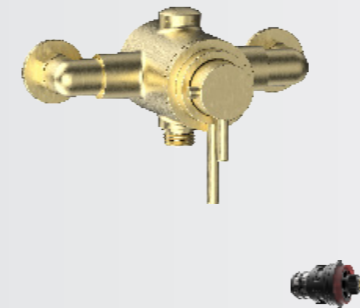
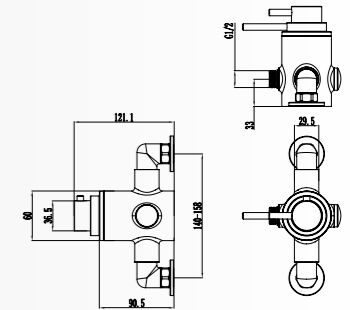

5019-20-BG

Push button thermostatic shower faucet

- 1-way H59 high quality casting brass body, Zinc handle
- PPA thermostatic cartridge+Vemet thermostatic sensor
- Finishing: ASS24H, PVD brushed gold, other color optional

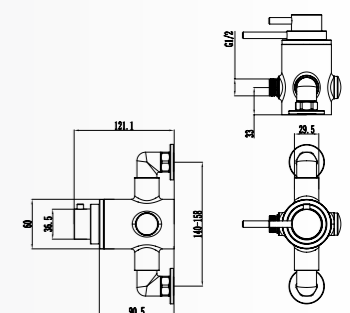

5022-20-CP

Vintage thermostatic shower valve

- 1-way H59 high quality casting brass body, Zinc handle
- PPA thermostatic cartridge+Vemet thermostatic sensor
- Finishing: ASS24H, chrome plated, other color optional

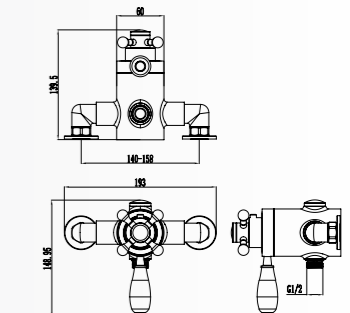

5022-20-MB

Push button thermostatic shower faucet

- 1-way H59 high quality casting brass body, Zinc handle
- PPA thermostatic cartridge+Vemet thermostatic sensor
- Finishing: ASS24H, electrophoresis Matte Black, other color optional

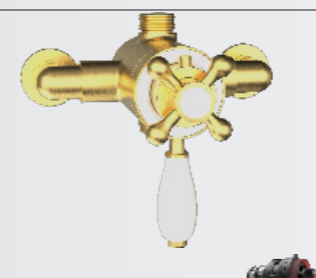
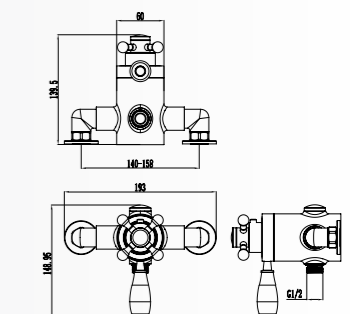

5022-20-BG

Push button thermostatic shower faucet

- 1-way H59 high quality casting brass body, Zinc handle
- PPA thermostatic cartridge+Vemet thermostatic sensor
- Finishing: ASS24H, PVD brushed gold, other color optional

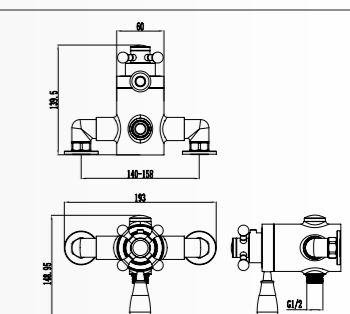

WE BRING YOU VALUE!



Yuson 雍成
WE BRING YOU VALUE

Shanghai Yuson Industry Co., Ltd | Yuson Group Limited(HK)

A: 18F No. 1690 Kongjiang Road, Shanghai, 200092, China

T: +8621 61075090, 61428791, 61428790

E: yuson@yusongroup.com

W: <https://www.yusongroup.com>



scan  to learn more

The content of this catalogue is limited. Yuson has abilities to provide OEM and ODM services for all our customers. If you don't find your favorite product in our catalogue, please contact our team at the first time, we will provide you with a one-stop solution according to your specific needs.

Copyright © Shanghai Yuson Industry Co.,Ltd. All Rights Reserved.